

TABLE OF CONTENTS

**Table Of Contents**

I	INTRODUCTION . . . . .	1
II	UNPACKING YOUR SAGE II/IV . . . . .	4
II.01	SETTING UP . . . . .	5
II.02	CONNECTING THE TERMINAL . . . . .	7
II.03	CONNECTING THE PRINTER . . . . .	9
II.04	DIP SWITCH SETTINGS . . . . .	10
II.05	CONFIGURING THE SAGE TERMINAL . . . . .	12
II.06	AC POWER CONNECTIONS . . . . .	16
II.07	THE KEYBOARD . . . . .	17
III	INITIAL POWER-UP . . . . .	21
III.01	HINTS ON POWER UP . . . . .	23
III.02	THE RESET BUTTON . . . . .	25
IV	BOOTSTRAP . . . . .	27
IV.01	BOOTSTRAPPING PROCEDURE . . . . .	28
V	DISKETTE CARE AND HANDLING . . . . .	29
V.01	INSERTING AND REMOVING DISKETTES . . . . .	32
VI	MENUS . . . . .	34
VII	BACKING-UP . . . . .	36
VII.01	FORMATTING DISKETTES . . . . .	38
VII.02	ZEROING A DISKETTE . . . . .	45
VII.03	COPYING DISKETTES . . . . .	48
	SAGE II with 2 FLOPPY DRIVES . . . . .	49
	SAGE II with 1 FLOPPY DRIVE . . . . .	50
	SAGE IV with HARD DISK . . . . .	52
VII.04	COPYING THE SAGE II/IV MASTER DISKETTES . . . . .	54
VII.05	CONGRATULATIONS . . . . .	55

## TABLE OF CONTENTS

VIII	<b>DEMONSTRATION</b>	57
IX	<b>p-SYSTEM PRIMER</b>	59
IX.01	USING THE p-SYSTEM	60
IX.02	EXITING FROM COMMAND LINE SELECTIONS	61
IX.03	THE p-SYSTEM MENU LINE	62
X	<b>THE p-SYSTEM FILER</b>	64
X.01	p-SYSTEM FILES	66
X.02	VOLUMES	67
X.03	PREFIX	69
X.04	LISTING THE FILES	71
	EXTENDED DIRECTORY	74
X.05	TRANSFERRING FILES	75
X.06	CHANGE	77
X.07	REMOVE	78
X.08	WILDCARDS	79
XI	<b>SYSTEM BASICS</b>	80
XII	<b>ELECTRONIC INFORMATION SERVICES</b>	82
XII.01	SAGEMAIL	84
XII.02	HARDWARE	85
XII.03	MODEM CABLES	86
XII.04	TELEMAIL	87
	SETTING UP YOUR TELEMAIL ACCOUNT	88
XII.05	ON-LINE WITH TELFMAIL	90
	HAYES MODEM AND TELFMAIL	91
	RECFIVING MESSAGES:	95
	SENDING MESSAGES	97
	LEAVING TELEMAIL:	99
	HANGING UP THE PHONE	100

TABLE OF CONTENTS

XIII	<b>P-SYSTEM TERMINAL CONFIGURATION</b>	102
XIII.01	COMMUNICATION PARAMETERS	102
XIII.02	TERMINAL CABLES	104
	STANDARD TERMINAL CABLE	105
	STANDARD REMOTE TERMINAL CABLE	106
	BUILDING A TERMINAL CABLE	107
XIII.03	RS232 PROTOCOL	109
XIII.04	Terminal XON/XOFF	112
	TERMINAL PORT OPTIONS	113
XIII.05	BUSINESS MASTER TERMINALS	114
XIV	<b>BUILD A USER MASTER</b>	115
XIV.01	VANILLA BOOT	116
XIV.02	LOADING BOOTSTRAP	117
XIV.03	SYSTEM.MISCINFO INSTALLATION	119
	SYSTEM.MISCINFO FILES	120
	KEYBOARD assignments	122
	SETUP.CODE	129
XIV.04	GOTOXY INSTALLATION	133
	GOTOXY AND THE LIBRARIAN	135
	GOTOXY PROGRAM	140
XIV.05	USER MASTER FILES	143
XIV.06	USER MASTER CHECKOUT	145
XV	<b>PRINTER INSTALLATION</b>	146
XV.01	PRINTER TYPES	147
	TI OMNI 810	148
	SIEMENS INKJET PRINTER	149
	SIEMENS INKJET PRINTER (AUX PORT)	150
	DEC LA50 PRINTER	151
	QUME SPRINT 9/45	152

TABLE OF CONTENTS

	DIABLO #630 PRINTER . . . . .	153
	NEC 3510 SPINWRITER . . . . .	154
	MICROLINE SERIES . . . . .	155
	QUME SPRINT 11 . . . . .	155
	NEC SPINWRITER 5530 PRINTER . . . . .	155
	RADIO SHACK DAISY WHEEL PRINTER . . . . .	155
	PARALLEL PRINTER CABLE . . . . .	156
XV.02	PRINTER PARALLEL PORT . . . . .	157
XV.03	PRINTER SPOOLING . . . . .	158
XV.04	PRINTER NOTES . . . . .	158
XVI	<b>SAGE4UTIL</b> . . . . .	159
XVI.01	MENU OPERATION . . . . .	161
XVI.02	RUNNING SAGE4UTIL . . . . .	163
XVI.03	CONFIGURATION CONTROL . . . . .	171
	A - Terminal configuration . . . . .	172
	Baud Rate . . . . .	172
	Parity . . . . .	173
	Stop bit . . . . .	173
	Data bits . . . . .	173
	XON/XOFF . . . . .	173
	BREAK KEY . . . . .	174
	B - Remote channel . . . . .	175
	REMOTE PORT XON-XOFF . . . . .	175
	REMOTE PORT DSR - DATA SET READY . . . . .	176
	C & D - Right & Left Floppy . . . . .	177
	E - RAM Disk . . . . .	179
	F - Printer . . . . .	180
	G-J - Extra Serial Ports #1-#4 . . . . .	181
	K - Parallel Port . . . . .	182

TABLE OF CONTENTS

	L - Time Adjustment . . . . .	183
	M - Low Level Configuration . . . . .	184
	BIOS Channel Map . . . . .	184
	Right & Left Floppy configuration . . . . .	186
	Shared Floppy Configuration . . . . .	190
	Winchesters #1 - #4 Configuration . . . . .	191
XVI.04	Auxiliary Device Information . . . . .	191
	Winchester Aux Device Info . . . . .	193
	Operating System Information . . . . .	194
XVII	<b>MULTI-USER</b> . . . . .	195
XVII.01	MULTI-USER OPTIONS . . . . .	196
XVII.02	MULTI USER OVERVIEW . . . . .	202
XVII.03	MULTI-USER CONNECTIONS . . . . .	203
	SETTING THE DIP SWITCHES ON THE SAGE . . . . .	204
	USING THE BUILD DISKETTE . . . . .	205
XVII.04	USING MULTI-USER . . . . .	212
	LOADING BUSINESS PROGRAMS . . . . .	213
	MORE ABOUT MULTI-USER . . . . .	214
XVII.05	MULTI-USER SPECIFICATIONS . . . . .	216
XVIII	<b>GLOSSARY</b> . . . . .	227
	<b>INDEX</b> . . . . .	250



**I INTRODUCTION :**

Congratulations on your selection of the SAGE™ II/IV microcomputer system. We've designed our machine from the ground up with performance in mind. We think that you'll quickly appreciate the SAGE II/IV's speed and its inherent advantages over other microsystems.

As with anything new, there will be a period of transition while you learn how to fully operate the SAGE and utilize its many features. However, this needn't be a painful process.

Computers are simply tools to help you do your job better; whether that job is letter writing, accounting, engineering, financial planning, computer science, or any of a thousand other tasks. Since our machine will be working for you, we encourage you to treat it as a friend. If you spend a little extra time getting acquainted now, you'll find the SAGE will return the favor by making things much easier for you in the future.

You may have already noticed that we've packed an awful lot of reading material with this computer. Rest assured that you needn't memorize it all before using your SAGE II/IV. Our system is a powerful tool for programmers and developers, but the SAGE II/IV is also designed with the first-time user in mind.

Our documentation and manuals reflect those diverse needs. In other words, you will have to read only those sections that apply to your application. If you are aiming at traditional microcomputer solutions, such as business and personal uses, you will probably find that the "In the Beginning" section of the GETTING STARTED MANUAL will answer most of your questions about operating the SAGE II/IV itself.

Software packages (the programs that make your computer into a useful tool) also have their own set of instructions. At

## INTRODUCTION

the back of this manual we've included the documentation for using the WORD/7 word processing package. The TIMBERLINE Spreadsheet is explained in a separate manual provided by TIMBERLINE. If you have purchased other software (a general ledger package for example), you will need to read the accompanying materials to run those applications.

Eighty-five percent of our users stop at this point and are able to operate the system fully to satisfy their complete processing needs. However, we have also included complete technical details for those with special needs.

If you are using a terminal other than the SAGE II/IV model, you will find setup notes in the "Installation" section of this manual. Likewise, those with the Winchester hard disk unit will also find details on that product in the "Installation Section." The same applies for those who will be using the Multi-User capabilities of their SAGE II/IV to support more than one terminal.

While it is not mandatory, you may find the enclosed book, "**Personal Computing with the UCSD p-System**", very helpful. It explains the p-System™, which serves as the prime operating system for the SAGE II/IV. An operating system allows a computer to handle duties such as running the floppy diskette drives, organizing files, and transferring information from place to place within the machine. While you are using word processing or any other application, you'll be unaware that the p-System even exists. It is useful to understand, however, when you are loading new programs, copying material from disk or diskettes, or preparing new diskettes for use.

Programmers and developers will find complete details on the technical aspects of the SAGE II/IV and the p-System in the 4 SAGE manuals: **p-System OPERATING SYSTEM, p-System PROGRAM DEVELOPMENT, SAGE II/IV TECHNICAL MANUAL, AND SDT-ASSEMBLER.**

Most importantly, don't let our little box, or any computer intimidate you. Pushing the wrong key is seldom fatal. In



fact, you'll find that the SAGE is an extremely forgiving piece of hardware. Before it allows you to make any really big mistakes, it gives you an opportunity to review most decisions.

Finally, if we use any terms you don't understand, please forgive us. Computer buzz words have corrupted our language, making it difficult to remember that everyone doesn't communicate through "input/output devices".

So relax, sit back, and enjoy your SAGE II/IV.



## II UNPACKING YOUR SAGE II/IV :

Since you're reading this manual, you've obviously unpacked at least a portion of your SAGE II/IV. If you haven't already done so, remove the manuals box, the SAGE II/IV itself, and the cables from the shipping cartons. Please check to see that you have the following items:

- SAGE II/IV
- AC power cord
- Cable "Terminal to Aux-470" (One for each terminal)
- Printer cable (Optional)
- SAGE Documentation (This volume and 4 others)
- "Personal Computing with the UCSD p-System"**
- TIMBERLINE Spreadsheet Manual
- SAGE Software Catalog

Additionally, the SAGE II/IV terminal (if ordered) will be packed in a separate box. Inside it you will find:

- Terminal screen
- Terminal keyboard
- The SAGE (QVT-102) Operator Manual

If you have ordered a printer with your SAGE II/IV, it too will be in a separate shipping container. Carefully check the packing list to make sure you remove all the contents. If purchased directly from SAGE Computer, your printer cable will be packed with the SAGE II/IV. Otherwise, the cable will be supplied by your dealer or the printer manufacturer.

If you are missing any of the items above, please contact your SAGE Computer dealer.

It is a good idea to save all the shipping cartons if possible. Should the need arise to return any of your hardware for maintenance purposes, they are designed to give maximum protection during transport.

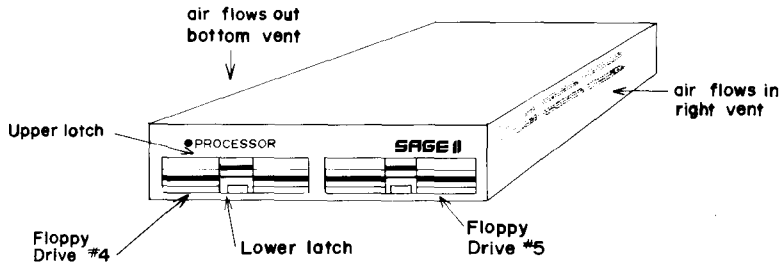

SAGE II

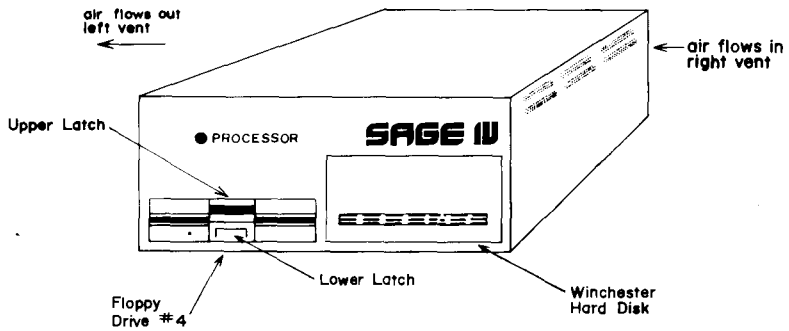

SAGE IV (With Hard Disk)

## II.01 SETTING UP :

The SAGE II/IV should be placed on a flat level surface for best operation. Adequate ventilation is mandatory. The SAGE II (see illustration on facing page) draws air into the machine on the right side; the fan exhausts from the bottom left hand corner. Both of these areas should be free from obstruction. The fan will work correctly while the machine sits on its feet, but make sure the fan port itself is not blocked by debris.

The SAGE IV with hard-disk has a higher cabinet. Air intake is again on the right side, but the fan exhausts from a port on the left-hand side of the case.

All SAGE II/IV's will also operate in a tilted environment as long as you do not exceed 15 degrees of tilt from full horizontal or vertical. However, it is difficult to provide adequate ventilation and access in these positions.

Follow the manufacturer's recommendation for placement of terminals and printers. The SAGE II/IV case will support the weight of most CRT units, should you wish to place your terminal on top of the computer.

At this time, remove the thin white cardboard protectors from the diskette drive units. You will see a small tab sticking out of each drive you have. If the protector does not easily slide out, check to see that the drive is not latched. You may disengage the latch by pressing in on the center section just below the diskette slot.

# UNPACKING YOUR SAGE II/IV SETTING UP

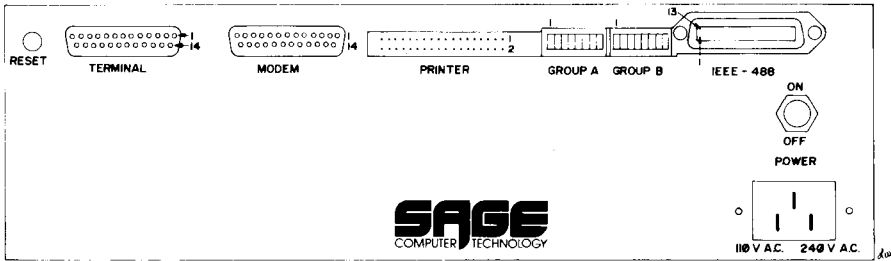

SAGE II

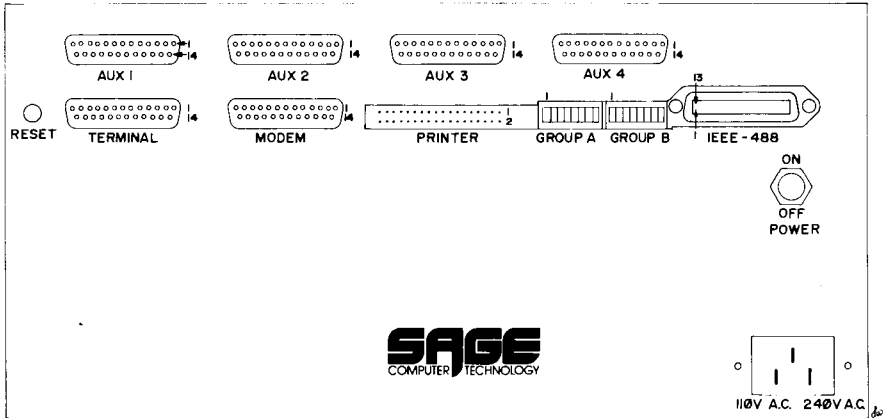

SAGE IV (With Hard Disk)

UNPACKING YOUR SAGE II/IV  
CONNECTING THE TERMINAL

**II.02 CONNECTING THE TERMINAL :**

If you purchased your terminal from SAGE, then follow the simple instructions given here. If not, refer to the more detailed section "p-SYSTEM TERMINAL CONFIGURATIONS" on page 201.

Your SAGE II/IV was shipped with a 10-foot cable to connect the terminal to the computer. This cable has gray connectors on each end. One end is labeled "TERMINAL" and the other end is labeled "AUX-470".

Insert the end marked "AUX-470" into the back of the SAGE II/IV on the port marked "TERMINAL". This plug is located at the left edge of your computer. The shape of the connector prevents it from being inserted upside down. It should attach easily without excessive force.

Although the cable connectors have screws to make a permanent connection, we do not make a provision for their use with the SAGE II/IV. While this may occasionally result in an accidental disconnect, we feel that it will also prevent the computer from ending up on the floor if the cable is accidentally jerked.

The other end of the cable marked "TERMINAL" should be inserted into the port on the back of the terminal marked "EIA". The screw mounts are provided on the terminal, should you choose to make a more permanent connection here.

Cables are also available in lengths up to 200 ft. for more convenient placement of terminals. They can be ordered from your SAGE Computer dealer.

Plug the SAGE Terminal keyboard into the left side of the terminal. This connector is similar to a phone jack, and should snap into place.

If you are planning a Multi-User system, one terminal should be attached to the "TERMINAL" port at this time. Later, additional terminals will be connected to the ports marked

UNPACKING YOUR SAGE II/IV  
CONNECTING THE TERMINAL

AUX 1-4 and the MODEM port. HOWEVER, at this time do not connect the additional terminals. Please complete the "In the Beginning" section of this manual with just one terminal, and then procede to the Multi-User" portion of the manual.



### II.03 CONNECTING THE PRINTER :

The SAGE II/IV will operate with a number of different printers. While these may differ widely in the method, or quality, of printing; there are just two different ways for them to talk to the computer: via the Serial port or the Parallel port. These terms refer to the method of data transmission between the two devices.

Serial printers will be connected to the SAGE II/IV using the "MODEM" port on the back of the computer. Parallel printers will use the connector marked "PRINTER".

The cables for these two types are easy to distinguish. A serial machine uses connectors just like the plugs on the computer-to-terminal cable. A parallel cable resembles a wide, grooved ribbon. The two connectors are not interchangeable.

If your printer and cable were supplied by SAGE or a SAGE dealer, you should be able to simply plug one end into the computer and the other end to the printer itself.

There is a chapter in the Installation section called "PRINTER INSTALLATION" which discusses printers and cables should you need further assistance.

Most printers also have one or more DIP switches. They should be set to the recommendations of the printer manufacturer. Check the owner's manual that came with your printer for details.

UNPACKING YOUR SAGE II/IV  
DIP SWITCH SETTINGS

II.04 DIP SWITCH SETTINGS :

Just about every piece of electronic gear manufactured today contains one or more DIP switches. These are small devices housing multiple switches. DIP stands for Dual In-line Package. These devices allow changing the machine by just moving the switch settings.

The DIP switches on your SAGE II/IV were preset at the factory to allow your computer to perform most tasks. Please double check to see that your switches match the settings shown below.

SAGE II

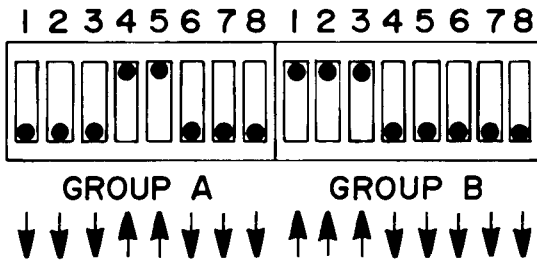

SAGE IV

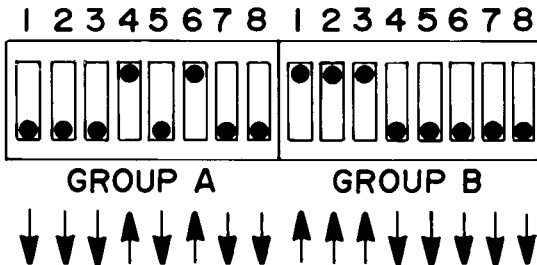

UNPACKING YOUR SAGE II/IV  
DIP SWITCH SETTINGS

A complete discussion of the DIP switches and alternative settings may be found in the Installation section of this manual.

**PLEASE RE-CHECK YOUR SETTINGS CAREFULLY**

These switches are very small and are easily mis-read. Be sure to look at them straight-on so you do not transpose the numbers.

## UNPACKING YOUR SAGE II/IV DIP SWITCH SETTINGS

### II.05 CONFIGURING THE SAGE TERMINAL :

A unique feature of the SAGE Terminal is that it does not have any DIP switches. However, you can still customize your terminal through use of the "Set Up" key.

To correctly configure your terminal to work with the SAGE II/IV system, power up the terminal. Re-check to insure that the power cord is connected to a 110VAC/60Hz outlet. Turn on the terminal using the black rocker switch located at the rear corner of the base. As you face the screen, this switch is to the right rear. A beep should occur within two seconds of turning the switch. If it does not, turn the switch in the other direction and check the power connection.

After 10 seconds, you should see a cursor appear in the upper left corner and a banner across the bottom of the screen. If these are missing, or appear dim, adjust the Screen Intensity knob on the front right corner of the base by turning it clockwise.

The banner at the bottom of the screen is known as the Status Line, and it displays the current configuration of the terminal. We can use the "Set Up" key to change any of the terminal characteristics. Press the "Set Up" key and notice that the cursor jumps to the first item in the line titled "On Line".

You can use the Right and Left Arrow cursor keys to move to any of the nine items on the bottom line. Try moving back and forth. Once you have selected which item you want, you can change it by using the Space Bar on the keyboard. Try this example:

UNPACKING YOUR SAGE II/IV  
CONFIGURING THE SAGE TERMINAL

Move the cursor to the right edge so it is on the item titled "9600". Press the Space Bar. Each time you press this bar, a different number will appear. This particular item sets the BAUD rate of the terminal. The SAGE II/IV requires a BAUD rate of 19200. Press the Space Bar until this item reads 19200.

All of the set up items work in a similar manner, working from left to right. Make sure that your banner looks like the one shown below. If it is different, use the Space Bar to change any needed items.

```
ON LINE |CHAR MODE |FDX |PROT OFF |KB ON |AUX OFF |(MON)OFF |GRAPH OFF |19200
```

## UNPACKING YOUR SAGE II/IV CONFIGURING THE SAGE TERMINAL

There are five more set up lines that may be changed. To see these, press the Down Arrow cursor key. The "Set 1" line should be displayed. As you did with the previous example, move through each item and make them match the configurations shown below:

```
SET 1  AUX/KB: AUX |REPEAT ON |CLICK OFF |MARGIN BELL OFF |EIA/CL: EIA |E.O.M.: NUL
```

If any item does not match, use the Space Bar to change it. Now, use the Down Arrow cursor key to move to the "Set 2" line. Match it to the line shown

```
SET 2  LINE WRAP ON |LINE FEED OFF |SCROLL ON |DISPLAY PE OFF |STD VID |X|ON ONLY
```

Check that the last item is "X-ON ONLY" and not "X-ON & DTR". Use the Down Arrow again to move to "Set 3". Match the items shown below:

```
SET 3  DATA BIT 8 |BITS 0 |PARITY OFF |PARITY BIT ODD |STOP BIT 1 |EMULATION SAGE  
                                             (GVT102)
```

This line should not have required any changes, but if it did, use the Space Bar to make the corrections. Use the Down Arrow to move to "Set 4". Match the items shown below:

```
SET 4  CURSOR BLOCK |CURSOR STEADY |HERE IS:      |TIME OFF |FREQ 60
```

Again use the Down Arrow to move to "Set 5" and match the items shown below:

```
SET 5  XPARENT OFF |KB TYPE: US
```

UNPACKING YOUR SAGE II/IV  
CONFIGURING THE SAGE TERMINAL

Now use the Up Arrow to move back through the Set Up lines and check your settings. When you are back to the start (ON LINE...), hold down the SHIFT key and press "S". This will save your changes into the terminal's memory. This also makes the cursor jump back to the top of the screen. You might want to go through the Set Up routine one more time. All the items should now be set correctly, and you need only press the "Set Up" key to return the cursor to the screen.

NOTE: Some of these items are mandatory such as the BAUD Rate and Parity setting, but others are a matter of preference such as blinking or non-blinking cursor. Please check the Operator Manual (Pgs. 19-26) which accompanied your terminal for full details.

The Status Line is displayed whenever you turn on your terminal. While some find it useful, others consider this a distraction. To turn off the Status Line, follow the procedure below:

Press "Set Up". Use the Space Bar to change ON LINE to LOCAL. Press "Set Up" again. Press <esc>. Hold down the SHIFT key and press <left bracket>. Press "Set Up". Use the Space Bar to change LOCAL to ON LINE. Press "Set Up".

UNPACKING YOUR SAGE II/IV  
AC POWER CONNECTIONS

**II.06 AC POWER CONNECTIONS :**

All models of the SAGE II/IV have similar connections on the rear panel, the only difference being that the SAGE IV features an extra row of four auxiliary ports.

Connect the female plug on the black power cord to the AC Inlet located on the back of the SAGE II/IV in the lower right-hand corner.

Check the bottom of your computer for a small white label which will indicate the proper power requirement; 110VAC or 220VAC.

If so configured, connect the male end of the plug to a 110VAC 60Hz or 50Hz power source (standard U.S. house current). Note that the power cord has a three-pronged safety plug to provide a reliable system ground. Use of a 3-to-2 pronged adapter is NOT recommended. If used, the adapter MUST BE GROUNDED properly.

Systems which have been changed for 220VAC operation will carry such a notation on the small white label affixed to the bottom of the SAGE II/IV.



## II.07 THE KEYBOARD :

There are as many different styles and designs of keyboards in the computer industry as there are clothes in the fashion world. However, the SAGE II/IV terminal is fairly close to standard.

You'll notice two main groups of keys: The **ALPHANUMERIC KEYS** and the smaller group to the right known as the **NUMERIC KEYPAD** .

Both have numbers, so which should you use? It really doesn't make much difference. With practice, you'll probably find that the numeric keypad is faster, and you'll never make a mistake because of the **SHIFT** key. Remember that an "8" on the alphanumeric keys could type as a "\*" if the SHIFT key is depressed. On the numeric pad, an "8" is always an "8".

At the top right edge of the keyboard you'll notice a short row of keys with the designations: **PF1, PF2, PF3 and PF4**. These are **PROGRAMMABLE FUNCTION KEYS** . Their use is controlled by software. In other words, they can change from program to program. For example, in the word processing package, PF4 is used to delete lines. In another program, this same key can be used for an entirely different purpose. These keys can have many other functions depending on the program you are running. You'll have to consult the instructions for each application to determine a PF-key's purpose.

# UNPACKING YOUR SAGE II/IV THE KEYBOARD

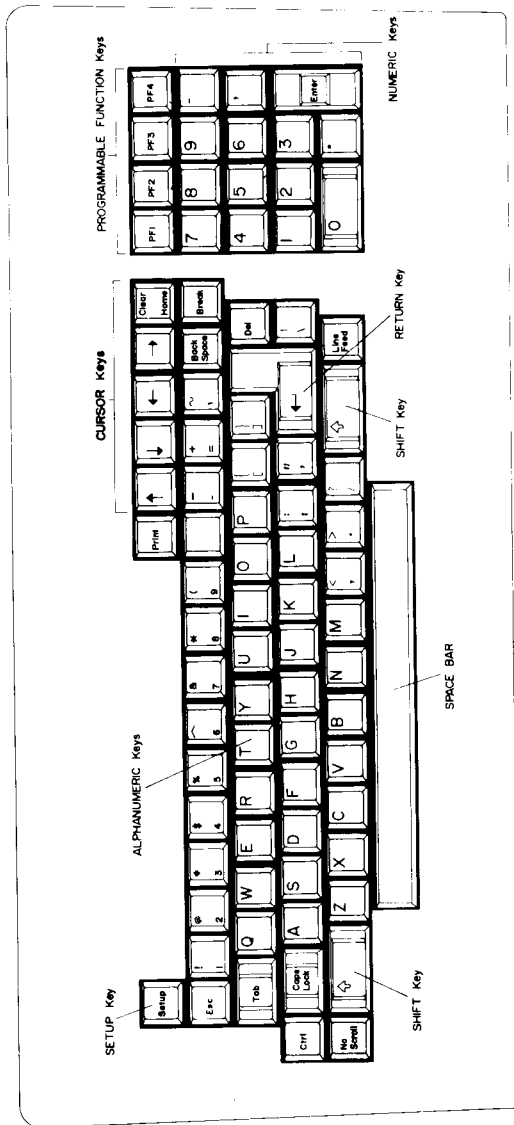

## UNPACKING YOUR SAGE II/IV THE KEYBOARD

To the left of the function keys, there are four keys with arrows. These are the **CURSOR KEYS**. They're self-explanatory. Push the up arrow and the cursor will go up one space. One important point to note is that they do not erase letters or characters as they move. On the other hand, if you use the space bar to move the cursor, everything it passes over will be erased. The cursor keys will move without creating blanks. You'll find that the cursor keys will become great friends as you spend more time with the SAGE II/IV.

Details of the SAGE keyboard are contained in the manual that was packed with your terminal. But here are a few quick tips:

The " ← " or " **ENTER** " keys generally perform the same function, and in most applications they are interchangeable. These two keys are often called "Carriage Return" or just <cr>. That is an old typewriter term that made it into the electronic age.

The " **DEL**" key is often called the Delete key or <del>.

The " **ESC** " key is called the Escape key or <esc>.

Depending on the nature of your printer or the type of character set or print wheel installed, all the keys may not print the characters shown on the keyboard. It is a good idea to make a test yourself. The biggest difference will probably be in the special characters above the numbers.

As you might expect, the **CAPS LOCK** key will shift your keyboard into all upper case letters and keep it there. However, it will not affect the special character keys like # \$ % & ] \* + = \_ < ? and many others. You will still have to use the **SHIFT** to change these keys to their shifted positions. **AND**, unlike some typewriters, the **CAPS LOCK** key will **NOT** release when you push the **SHIFT** key. **REMEMBER**, when the **CAPS LOCK** is down, everything will be in capital letters until you release it. On the SAGE terminal, you'll notice the letters **CAPS** in the lower left-hand corner of the screen

## UNPACKING YOUR SAGE II/IV THE KEYBOARD

anytime the CAPS LOCK key is depressed. This is a helpful reminder.

The LINE FEED key is the same as the down arrow cursor key.

The SETUP key is used to configure your terminal with specific attributes. Details are contained in the "DIP SWITCH SETTING" portion of this manual under the subheading: "Configuring the Terminal" and in the operator manual which accompanied the terminal.

The "." and the "," and the "-" are interchangeable between the alphanumeric and numeric keys. Use which ever one suits your fancy.

Note that the 0, which is the number zero, is different from the capital letter O. These two look the same on a printed page, but on the screen you'll notice that the zero has a diagonal cross bar. These two are definitely NOT interchangeable.

Once again, refer to the terminal manual or program documentation for more specific details on keyboard functions.

### III INITIAL POWER-UP :

The power switch for the SAGE terminal is located at the back of the machine. When facing the screen, this switch is in the lower right hand corner. It is a rocker type switch, and depressing the side nearest the right edge of the terminal will turn on the machine. With use, you will quickly learn to feel for this switch. Turn **ON** your terminal.

The ON/OFF power switch for the SAGE II/IV is located directly above the AC Inlet for the power cord. To turn the power on, the switch toggle should be up. Down will turn off the power. Turn **ON** your SAGE II/IV microcomputer.

It makes no difference which device you turn on or off first. The Basic Input/Output System (BIOS) of the SAGE II/IV ignores any illegal characters generated by the terminal so that a program will not be affected if the terminal is turned on/off during execution.

If you have a **SAGE II** , after a few moments the screen should display the following:

```

-----
. SAGE Startup Test [xx] .
. RAM SIZE = xxx K .
. . .
. Booting from Floppy .
. Put in BOOT disk and press a key (Q-quits) .
-----

```

Do not put in a diskette at this time. If you had no problems Powering Up, turn to page 27.



### III.01 HINTS ON POWER UP :

Power consumption for all SAGE microcomputers is extremely low. At rest, our largest model draws about the equivalent of a standard 75-watt light bulb. Since most component stress occurs during startup, we recommend leaving your machine ON as much as possible.

One additional benefit of this procedure is that the SAGE II/IV will always be at peak operating state. If the temperature environment drops below 50 degrees F, we suggest a warm up period before attempting to process data.

On SAGE IV equipment, a cold start may result in a "Drive Error 08" message. Let the machine run for approximately 15 minutes, and then press the RESET button.

You should find that low-cost "surge protectors" will not be necessary for your SAGE micro, as all SAGE II/IV's have an RF/EMI filter on the AC power line. HOWEVER, we strongly recommend that your machine and terminal be turned OFF during local electrical storms to prevent damage or data loss.

INITIAL POWER-UP  
HINTS ON POWER UP

**HELP!**

Did something go wrong?

(If not, turn the page and learn about "Booting Up".)

**THERE'S NOTHING ON THE TERMINAL.** Check to see that the contrast knob on your terminal is properly adjusted. On the SAGE terminal, this control is located on the base in the front right-hand corner. Turn the knob clockwise to increase the intensity contrast.

**THERE'S STILL NOTHING ON THE TERMINAL.** Make sure the terminal is working. The SAGE terminal should beep when you turn it on or off. If it didn't, it may not be getting power. Check the plug. Check the fuse located in the back near the power cord.

**IS THE SAGE II/IV WORKING?** When you turned on the SAGE II/IV, you should have heard the fan start. If your unit is silent, check the connection to the AC outlet. The small light labeled PROCESSOR on the front panel should be glowing red or green. It changes from red-to-green while the machine is processing data, but it should always be lit while the SAGE II/IV is switched ON.

**THE MESSAGE ON THE SCREEN IS GARBLED.** Go back and review the section on DIP switch settings. Make sure each switch is correct. Re-check the Setup procedures for the SAGE terminal, the BAUD rate and Parity settings in particular.

**DRIVE ERROR 08?** This message might appear on SAGE IV Systems. It generally indicates that the machine is cold. Press the reset button at the back of the SAGE IV. If you receive another 08 error, let the machine warm up for approximately 15 minutes. Then press the RESET button.

**STILL NOTHING?** Review all the cable hookups described in the preceding pages. Then try pressing the RESET button located on the back of the SAGE II/IV. It is the small



button that is nestled between the right edge and the terminal connector. If that doesn't help, throw in the towel and call your nearest SAGE dealer.

### III.02 THE RESET BUTTON :

On the rear panel of the SAGE II/IV, there is a small button located next to the TERMINAL plug marked RESET.

This is not a circuit breaker, but rather it resets or aborts the current process and begins the power-up procedure. This causes the SAGE II/IV to reboot. Diskettes do not need to be removed when using the RESET button.

It is STRONGLY ADVISED that you not be too hasty in using the reset button to get out of an unfamiliar procedure. Information that has just been typed in or is on RAM DISK will be lost! We suggest you try the following first:

- 1) Type the ESC key twice followed by a <cr>. If a new screen does not appear then go to step 2.
- 2) Type CTRL/Q. You may have accidentally typed CTRL/S which stops the terminal. Typing CTRL/Q will start it again.
- 3) Type CTRL/@. This should "break" out of the program you are in. This key may be different on other terminals. A message should appear on the bottom line asking you to type a space.
- 4) If you are working in the SAGE Multi-user system, type the "BREAK" key. This will allow you to reboot your system without disturbing the other users. You will lose any temporary information just as if you reset under the single-user system.

## INITIAL POWER-UP THE RESET BUTTON

Only as a last resort should you reset the system. (If you are a Multi-user, it is a good idea to check with the other users before hitting the button.)

In the next section you will learn about "Bootstrapping". Once you have completed that section, you may wish to test the RESET button.

#### IV BOOTSTRAP :

Once you've turned on your SAGE II/IV, it's like the proverbial character who's all dressed up with no place to go. Until you've "booted" an operating system into the machine, it really can't do much.

The term "boot" or "bootstrapping" most likely comes from the old saying: "Pull yourself up by your bootstraps." That's a reference to getting yourself started when you're down. In that sense, it's quite an accurate technical term as well; it gets the computer going.

When you boot your SAGE II/IV, you give it an operating system. The operating system in turn instructs the microcomputer how to process data, establish files, etc.

The SAGE II/IV is an extremely versatile machine, and allows you to boot to quite a few different operating systems. Our main operating system, however, is the p-System. SAGE II/IVs are shipped from the factory with the p-System either on the hard disk or on a separate floppy diskette.

The p-System, like other operating systems, includes many useful utilities ranging from editors to disk filers. But, your SAGE II/IV can be booted using only parts of the p-System. That's because certain programs or applications do not need all the features of the p-System to work. An example is our own BUSINESS diskette. While it includes some p-System files, it does not have them all, just those needed to run the word processing and spreadsheet programs. The SYSTEM diskette on the other hand is a complete version of the p-System and includes all files and utilities available.

Some of you may never need to use the operating system by itself other than to make backup copies of diskettes, but it is helpful to understand some of the terms associated with it, like bootstrap.

BOOTSTRAP  
BOOTSTRAPPING PROCEDURE

IV.01 BOOTSTRAPPING PROCEDURE :

The bootstrapping function is automatic on the SAGE IV .

When you turn on the power, the machine (after a brief warmup) will automatically boot to Partition #1 of the disk which has the p-System and BUSINESS files.

If you have the SAGE II , you must perform the bootstrapping manually. If you are unfamiliar with microcomputers and floppy diskettes, please read the section on "Diskette Care and Handling" on the next page before proceeding.

The drawings opposite page 5 show how drives are numbered. Insert the diskette marked BUSINESS into Drive #4. This is the left-hand drive as you face your SAGE II. Close the drive latch. Press any key other than "Q". **If your terminal has NOT been pre-configured** , your screen should now display the QUICK TERMINAL INSTALLATION MENU. Select the letter for the terminal that you have. If you are using a terminal that is not shown on the menu, refer to the INSTALLATION section of this manual.

QUICK TERMINAL INSTALLATION MENU

- S- SAGE or QVT102
- T- TELEVIDEO TV925
- F- FREEDOM 100
- A- ABORT

Select the letter for the terminal you have:

**If your terminal has been pre-configured** , your screen should now display the SAGE logo.

## V DISKETTE CARE AND HANDLING :

The SAGE II/IV microcomputer uses 5-1/4-inch diskettes for storing programs and data outside of the computer. These are also known as floppies, or floppy disks, or mini-diskettes.

The 80-track drives that are standard on all SAGE II/IV models use two-sided, double-density, soft sectored diskettes. Each diskette is capable of holding 640K bytes of information, or over 650,000 characters.

Be sure and look for diskettes qualified for 96 tracks per inch. There should be "96 TPI" stamped on these diskettes.

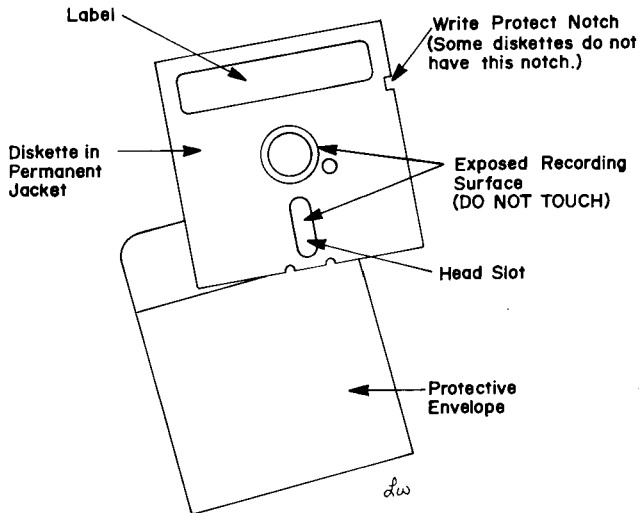

## DISKETTE CARE AND HANDLING

All diskettes should be handled with care. **DO NOT** touch the exposed record surfaces. They are extremely sensitive, and important data can be destroyed with just a fingerprint or a speck of dust.

The donut-like hole in the center is where the diskette drive attaches to spin the surface like a record. The long slot below the hole is where the head reads or writes data much like a tape recorder head. The small hole is for alignment purposes. Again, do not touch any of these areas.

Diskettes should be returned to their protective envelopes as soon as they are removed from the SAGE II/IV diskette drives. Your diskettes should be stored away from heat, dust and magnetic sources such as speakers, motors, calculators, telephones or magnets.

Physically, be sure that the diskettes are not damaged by placing heavy objects on them. During storage, insure that they are not sagging or bending. Be sure that you use only a soft-tipped felt pen to write on the diskette labels. Ball points or pencils will damage the surface of the diskette inside.

Notice the notch at the top right-hand edge of your diskettes. This notch may be covered with an opaque piece of tape or a sticker. It is known as a "write-protect notch". When this notch is exposed, you may read or write material to the diskette. When it is covered, you can only read data. In other words, you can tape over the notch to make sure that your material is not erased accidentally.

The four SAGE II/IV diskettes: **BUSINESS, SYSTEM, UTILITY, and BUILD**, should all be write-protected with small silver stickers. These stickers are removable, but we DO NOT recommend that you do so.

## DISKETTE CARE AND HANDLING

Even with the best of care, diskettes may fail for no apparent reason. Therefore, the only real protection is to keep a spare, or backup copy. We'll talk about that important process in just a moment.

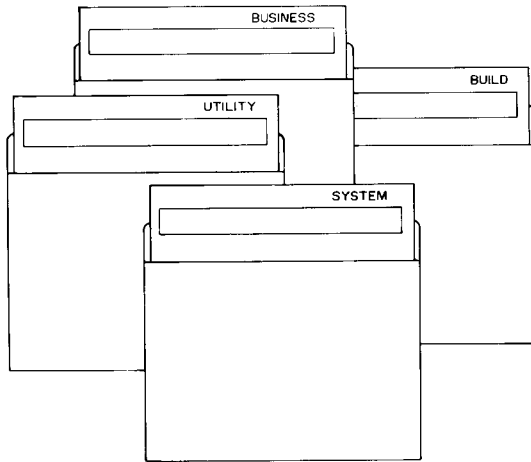

DISKETTE CARE AND HANDLING  
INSERTING AND REMOVING DISKETTES

**V.01 INSERTING AND REMOVING DISKETTES :**

The diskette drives in your SAGE II/IV are quite easy to use. To insert a floppy into the machine, first remove it from the protective envelope. Next, with the label facing up and toward you, insert the diskette into the drive slot.

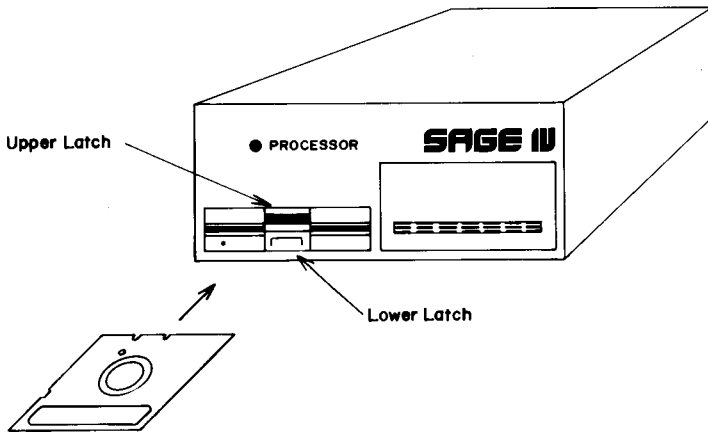



## DISKETTE CARE AND HANDLING INSERTING AND REMOVING DISKETTES

Gently push the diskette forward with your finger until it stops. You should hear a slight click as it reaches the back of the drive. No force is required. Pushing too hard could damage the diskette.

To prevent bending the front edge, make sure that the diskette is firmly in before actually closing the top latch. Once in place, press straight down on the top latch. It will click into position and lock.

Before removing any diskette, make sure that the drive is NOT in use. There is a small red indicator light located to the left of the latch, below the diskette slot. If the light is on, the drive is in use. IF IT IS OFF, you may remove diskettes.

To remove one, push forward on the lower latch just below the slot. The top latch should snap up, allowing the diskette to pop out like bread in a toaster.

If it does not jump out, jiggle the top latch up and down. This should free the diskette. Make sure that the diskette is still firmly in, before actually re-closing the top latch.

Slide the diskette straight out (pulling up might bend it) and immediately replace it in a protective envelope.

## MENUS

### VI MENUS :

The computer industry has borrowed words from everyone. BOOTSTRAP was stolen from the cowboys, and MENU was lifted from the neighborhood restaurant.

At the diner, you select the item you want from the menu of available dishes. Same thing with computers. A list of options is presented, and you make a selection. You'll find that a great deal of the software in the industry uses some form of "Menu Control" to choose options.

The SAGE Main Menu shown below is very typical.

#### SAGE II/IV Main Menu

---

WORD/7 Word Processing  
TIMBERLINE Spreadsheet  
Demonstration  
Communications  
p-System

To display the SAGE Main Menu, anytime the SAGE logo is displayed on the screen, press any key. The menu will now appear. (See BOOTSTRAPPING PROCEDURE for details on displaying the SAGE logo)

Notice the cursor next to the item "WORD/7 Word Processing". You may move this up and down by either of the cursor keys shown below.

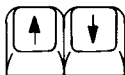

Try moving it up and down. This is how you select an item. To actually order that item, position the cursor next to the desired selection, and press <cr>. (That's the "←" "RETURN" or "ENTER" key). DO NOT MAKE ANY SELECTIONS AT THIS TIME. Read the BACKING-UP information first.

## BACKING-UP

### VII BACKING-UP :

\*\*\*\*\* IMPORTANT - PLEASE READ \*\*\*\*\*

We know that you are anxious to use your SAGE II/IV right away, but it is important that you take a few minutes now and back up the diskettes that were shipped with your system. As we said in previous pages, diskettes DO die.

To insure that your main diskettes survive, you should back them up (make a spare copy) immediately before using any of the programs or operating system features of your SAGE II/IV. If you are unfamiliar with the p-System, the following exercise will take you through a backup procedure step-by-step.

In addition, you may want to refer to this section anytime that you wish to make a copy of any diskette containing data or programs.

#### BackUp Exercise

To complete this exercise you will need the following:

One blank two-sided, double-density diskette for each master to be copied [Four (4) total] Blank diskettes may be obtained from your SAGE dealer or from computer/office supply stores.

The four MASTER DISKETTES which came with your machine: BUSINESS, SYSTEM, UTILITY, AND BUILD.

There are three steps required to make a BackUp Copy. First

the blank diskette must be **FORMATTED** . This divides a new diskette into various sectors and tracks which the SAGE II/IV can access.

Next, the formatted diskette must be **ZEROED** . This essentially puts a table of contents, or directory, on the diskette and gives it a name. This procedure allows the SAGE II/IV to find certain files at various locations on different diskettes.

And finally, you will **COPY** the material from the master diskette to the new backup copy.

If your SAGE terminal is not currently displaying the SAGE logo on the screen, follow the procedures described earlier under INITIAL POWER-UP. If you have a standard machine, use the BUSINESS diskette to perform the boot procedure.

Press any key to get to the SAGE Main Menu. Select p-System from the list (See MENUS for details). Press <cr>. Answer the question to continue by pressing "y".

Follow the **FORMATTING** instructions on the following pages which apply to **your type of machine** . Then skip to **ZEROING DISKETTES**.

BACKING-UP  
FORMATTING DISKETTES

VII.01 FORMATTING DISKETTES :

SAGE II with 2 diskette drives

To begin the FORMAT procedure, select the "p-System" option from the SAGE Main Menu. Press <cr>. Press "y". When the Command Line appears, follow the instructions below step-by-step:

(Note: <cr> denotes the " ← " or "ENTER" key.)

THE SCREEN SHOWS:	YOU TYPE:
Command: E(edit, R(un, F(file, C(omp....	x
Execute what file?	sage4util
SAGE4UTIL	
A - On-line Configuration	
B - BIOS file Configuration	
C - Floppy Formatter	
D - Bootstrap Copy	
Select Menu item <CR exits, ! aborts>: Floppy Diskette Formatter	C
Drive to be formatted - L(left or R(ight?	R

INSERT A BLANK DISKETTE INTO DRIVE #5. (Right side)

Is diskette ready for formatting in Right drive? y

FORMATTING WILL AUTOMATICALLY BEGIN.  
THIS TAKES APPROXIMATELY 90-120 SECONDS TO COMPLETE

BACKING-UP  
FORMATTING DISKETTES

THE SCREEN SHOWS:

YOU TYPE:

```
Formatting
.....
.....
.....
.....
Verification
.....
.....
.....
.....
```

```
Format Complete
More diskettes to format?
```

```
y (if more)
n (if done)
```

SAGE4UTIL

- A - On-line Configuration
- B - BIOS file Configuration
- C - Floppy Formatter
- D - Bootstrap Copy

```
Select menu item <CR exits, ! aborts>: <cr>
Command: E(edit, R(un, F(ile,..... i
```

SAGE Logo

If you had a problem, refer to HELP at the end of the FORMAT section. Once you have formatted the diskettes necessary to make copies, you will have to ZERO each of them. See "ZEROING DISKETTES".

BACKING-UP  
FORMATTING DISKETTES

SAGE IV

To begin the FORMAT procedure, select the "p-System" option from the SAGE Main Menu. Press <cr>. Press "y". When the Command line appears, follow the instructions below step-by-step:

(Note: <cr> denotes the " ← " or "ENTER" key.)

THE SCREEN SHOWS:	YOU TYPE:
Command: E(edit, R(run, F(file, C(comp.....	x
Execute what file?	sage4util

SAGE4UTIL

- A - On-line Configuration
- B - BIOS file Configuration
- C - Floppy Formatter
- D - Bootstrap Copy
- E - Prepare Drives for Shipping

Select Menu item <CR exits, ! aborts>:	C
Floppy Diskette Formatter	
Drive to be formatted - L(left or R(right)?	L

INSERT A BLANK DISKETTE INTO DRIVE (#4:)  
(Top drive if you have two)

Is diskette ready for formatting in Left drive? y

FORMATTING WILL AUTOMATICALLY BEGIN.  
THIS TAKES APPROXIMATELY 90-120 SECONDS TO COMPLETE



BACKING-UP  
FORMATTING DISKETTES

THE SCREEN SHOWS:

YOU TYPE:

```
Formatting
.....
.....
.....
Verification
.....
.....
.....
```

```
Format Complete
More diskettes to format?
```

```
y (if more)
n (if done)
```

SAGE4UTIL

- A - On-line Configuration
- B - BIOS file Configuration
- C - Floppy Formatter
- D - Bootstrap Copy
- E - Prepare Drives for Shipping

```
Select Menu item <CR exits, ! aborts>: . <cr>
Command: E(edit, R(run, F(file,..... i
```

SAGE Logo

Once you have formatted the diskettes necessary to make copies, you will have to ZERO each of them. See "ZEROING DISKETTES".

BACKING-UP  
FORMATTING DISKETTES

**SAGE II with 1 diskette drive**

To begin the FORMAT procedure, select the "p-System" option from the SAGE Main Menu. Press <cr>. Press "y". When the Command Line appears, follow the instructions below step-by-step:

(Note: <cr> denotes the " ← " or "Enter" key.)

THE SCREEN SHOWS:	YOU TYPE:
Command: E(edit, R(un, F(file, C(comp.....	x
Execute what file?	sage4util
SAGE4UTIL	
A - On-line Configuration	
B - BIOS file Configuration	
C - Floppy Formatter	
D - Bootstrap Copy	
Select Menu item <CR exits, ! aborts>:	
Drive to be formatted -L(Left or R(ight	L

REMOVE BUSINESS DISKETTE FROM THE DRIVE.  
INSERT A BLANK DISKETTE

Is diskette ready for formatting in Left drive? y

FORMATTING WILL AUTOMATICALLY BEGIN.  
THIS TAKES APPROXIMATELY 90-120 SECONDS TO COMPLETE

BACKING-UP  
FORMATTING DISKETTES

THE SCREEN SHOWS:

YOU TYPE:

```
Formatting
.....
.....
.....
.....
Verification
.....
.....
.....
.....
```

```
Format Complete
More diskettes to format?          y (if more)
                                      n (if done)
```

WHEN DONE, REMOVE FORMATTED DISKETTE  
INSERT BUSINESS DISKETTE

SAGE4UTIL

- A - On-line Configuration
- B - BIOS file Configuration
- C - Floppy Formatter
- D - Bootstrap Copy

```
Select Menu item <CR exits, ! aborts>:  <cr>
Command: E(edit, R(run, F(file, C(comp.....  i
```

SAGE Logo

Once you have formatted the diskettes necessary to make copies, you will have to ZERO each of them. See "ZEROING DISKETTES".

BACKING-UP  
FORMATTING DISKETTES

**HELP!**

Did you have trouble **FORMATTING** a diskette?

(If not, go on to the section on **ZEROING** a diskette.)

First, take the diskette out and put it back in, checking to see that it "seats" properly. Try formatting again. Also check to see that the center hole of the disk is centered in the hole of the envelope before inserting the disk.

If the following message occurs as soon as you begin the format:

```
Error 16 while formatting Cylinder 0 Head 0
Type <space> to continue
```

You are trying to format a diskette that is "write protected". Be sure that you are not destroying a **MASTER** diskette or other important data. You may continue the procedure by removing the sticker from the write-protect notch on the diskette. Once again, be sure you want to use this diskette. **FORMATTING** will erase all information on any diskette.

If the **FORMAT** or **VERIFICATION** pass failed to complete, you will receive an error message similar to the one shown below:

```
Error 1 while checking Cylinder 40 Head 0
Type <space> to continue
```

This message indicates that the **SAGE** found a problem on your diskette. Try the format procedure one more time. If you receive the same error message, your diskette is faulty.

## VII.02 ZEROING A DISKETTE :

Zeroing is a way of naming a blank diskette and putting a "directory" on it. The directory serves as a table of contents for each diskette so that the SAGE II/IV can find the files in the proper places. While you may vary the procedure for special needs, we recommend that you use some conventions. When asked, you should select a "duplicate directory" unless space needs on your diskette are critical. This gives you some protection in case one of the directories is damaged. Also we recommend that you set up your diskettes for 1280 tracks. This is the ideal maximum for the double-sided, double-density diskettes.

To ZERO your diskettes, follow the instructions below:

If your SAGE terminal is not currently displaying the SAGE logo on the screen, follow the procedures described earlier under INITIAL POWER-UP. If you have a SAGE II, use the BUSINESS diskette to perform the boot procedure.

Press any key to get to the SAGE Main Menu. Select "p-System" from the list (See MENUS for details). Press <cr>. Answer the question to continue by pressing "y".

Proceed using the chart below:

Note that any time the filer is used on a single floppy SAGE II, it should be locked into memory with the "f" command before removing the floppy disk.

THE SCREEN SHOWS:	YOU TYPE:
Command: E(edit, R(un, F(ile, C(omp....	f
Filer: G(et, S(ave, W(hat, N(ew.....	f
Filer segments memlocked. [ ]	
Filer: G(et, S(ave, W(hat, N(ew.....	z
Zero dir of what vol?	#4: or #5:

INSERT A FORMATTED DISKETTE INTO DRIVE #4 or #5  
(If you only have one drive, remove BUSINESS diskette)

BACKING-UP  
ZEROING A DISKETTE

The drawings opposite page 5 show how the drives are numbered. Normally, SAGE II users leave their main diskette in #4: and format and zero new diskettes in #5:. SAGE IV users normally use #4:.

```
Duplicate dir?          y
# of blocks on disk?   1280
New vol name?          (Any name you choose.
                       7 characters maximum)

(Your choice): correct?
(Your choice): zeroed
File:G(et, S(ave, W(hat, N(ew.....  q
Command: E(dit, R(un, F(ile, C(omp...  i
```

If you had trouble, see the HELP section on the next page.

After completion of this procedure, your diskette is ready for use.

**HELP!**

Did you have trouble ZEROING a diskette?

(If not, continue to COPYING A DISKETTE.)

When I tried to ZERO my diskette, I got the following message:

```
4: - No such vol on-line <source>
```

This error message indicates that the SAGE II/IV couldn't find your diskette. There are several reasons why this might happen. The diskette may not be properly seated on the drive spindle. Remove the floppy and re-insert it into the drive. If it doesn't work the first time, try it once more. You should hear a sharp "click", not a dull thud.

Is your diskette in the correct slot? Drive #4 is on the left as you face your SAGE II.

The diskette may not have been properly FORMATTED. Re-format your diskette. This procedure will also detect a faulty diskette.

BACKING-UP  
COPYING DISKETTES

**VII.03 COPYING DISKETTES :**

The following procedure may be used to make BackUp Copies of any diskettes. It will result in an exact duplicate copy of one diskette on another. This procedure will be helpful any time you wish to make a spare copy of programs or data.

You should follow this procedure to make a copy of each one of the SAGE II/IV Master Diskettes: **BUSINESS, SYSTEM, UTILITY, and BUILD .**

To begin the COPY procedure, select the "p-System" option from the SAGE Main Menu. Press <cr>. Answer the question to continue by pressing "y". When the Command Line appears, follow the instructions on the next few pages, **according to your machine type .**



● SAGE II with 2 FLOPPY DRIVES

Insert the diskette to be copied into Drive #4 (left side).  
Insert the blank (formatted and zeroed) diskette into Drive  
#5 (right side).

THE SCREEN SHOWS:	YOU TYPE:
Command: E(dit, R(un, F(ile, C(omp....	f
File: G(et, S(ave, W(hat, N(ew.....	f
File segments memlocked. [ ]	
File: G(et, S(ave, W(hat, N(ew.....	t
Transfer what file?	#4:,#5:
Transfer 1280 blocks?	y
Destroy (Name of blank diskette)?	y

THE COPY PROCEDURE WILL AUTOMATICALLY BEGIN  
(If you wish to remain in the p-System,  
do not type the "i" at the end of this procedure.)

(Name of master): ---> #5:

File: G(et, S(ave, W(hat, N(ew..... q

Command: E(dit, R(un, F(iler, C(omp..... i

SAGE Logo

(Note: This method makes a complete image copy of the left diskette onto the right diskette. Even the name that you gave your volume during zeroing will be erased and replaced by the name of the left diskette. Do not attempt to continue using the system with two diskettes which have the same name. The SAGE II is smart, but not that smart. Once an image copy is complete, one or the other diskettes should be removed.)

BACKING-UP  
COPYING DISKETTES

● SAGE II with 1 FLOPPY DRIVE

Leave the BUSINESS diskette in the drive, and follow the instructions below step-by-step:

(Note: <space> denotes pressing the long space bar on the keyboard)

THE SCREEN SHOWS:	YOU TYPE:
Command: E(edit, R(run, F(file, C(comp.....	f
File: G(et, S(ave, W(hat, N(ew.....	f
File segments memlocked. [ ]	
File: G(et, S(ave, W(hat, N(ew.....	t

THIS PROCEDURE IS TIME CONSUMING. YOU WILL HAVE TO SWITCH THE MASTER DISKETTE AND THE COPY DISKETTE IN AND OUT OF DRIVE #4 ON THE SAGE II. THIS MAY REQUIRE UP TO 20 SWAPS.

Transfer what file?	#4:,#4:
Transfer 1280 blocks? (Y/N)	y

(SWITCH DISKETTES)

Insert destination disk	
Type <space> to continue	<space>

Destroy (Vol name of copy diskette):?	y
---------------------------------------	---

(SWITCH DISKETTES)

Put (Vol name of master diskette) in unit #4	
Type <space> to continue	<space>

(SWITCH DISKETTES)

BACKING-UP  
COPYING DISKETTES

Put (Vol name of copy diskette) in unit #4  
Type <space> to continue <space>

(SWITCH DISKETTES)  
AND SO ON...AND SO ON UNTIL....  
(If you wish to remain in the p-System,  
do not type the "i" at the end of this procedure.)

(Vol name of master diskette): ---> #4:  
Filer: G(et, S(ave, W(hat..... q

Command: E(dit, R(un, F(ile, C(omp,..... i

SAGE Logo

BACKING-UP  
COPYING DISKETTES

● SAGE IV with HARD DISK

This method of copying diskettes transfers all of the information from the original floppy to the SCRATCH: area on the hard disk and then back to a new diskette in the floppy drive. This is generally the fastest way to copy on a SAGE IV with only one floppy drive. If the SAGE IV has **two** floppy drives, then diskettes can be copied using the method for a SAGE II with 2 floppy drives.

Insert the diskette to be copied into Drive #4.

(TYPE THE FOLLOWING COMMANDS AS SHOWN)

THE SCREEN SHOWS:	YOU TYPE:
Command: E(edit, R(run, F(file,....	f
File: G(et, S(ave, W(hat.....	t
Transfer what file?	#4: <cr>
To where?	#10:
Transfer 1280 blocks? (Y/N)	y
Destroy volume:?	y <cr>

TRANSFER TO A SCRATCH AREA ON THE HARD DISK WILL BEGIN AUTOMATICALLY. THE FILER LINE WILL APPEAR WHEN TRANSFER IS COMPLETE.

NOW YOU WILL TRANSFER THE INFORMATION FROM THE HARD DISK ONTO A BLANK DISKETTE. REMOVE THE DISKETTE FROM DRIVE #4, AND INSERT A BLANK (Formatted and Zeroed) DISKETTE IN DRIVE #4.

THE SCREEN SHOWS:	YOU TYPE:
File: G(et, S(ave, W(hat, N(ew....	t
Transfer what file?	#10: <cr>

BACKING-UP  
COPYING DISKETTES

```
To where? #4:
Transfer 1280 blocks? y
Destroy volume:? y
<cr>
```

THE COPY WILL AUTOMATICALLY BEGIN. THE FILER LINE WILL APPEAR WHEN COPY IS COMPLETE. NOW YOU WILL RENAME YOUR SCRATCH AREA FOR FUTURE USE.

```
Filer: G(et, S(ave, W(hat, N(ew.... z
Zero dir of what vol? #10:
Destroy previous volname:? <cr>
Duplicate dir? y
Are there 1280 blocks on the disk? (Y/N) y
New vol name? scratch
SCRATCH correct? y
SCRATCH zeroed
Filer: G(et, S(ave, W(hat, N(ew.... q
Command: E(dit, R(un, F(ile, C(omp... i
SAGE logo
```

Note that the steps above return you to the SAGE logo. Do not type the "i" to remain in the p-System command line.

BACKING-UP  
COPYING THE SAGE II/IV MASTER DISKETTES

**VII.04 COPYING THE SAGE II/IV MASTER DISKETTES :**

If you have not already done so, follow the COPYING DISKETTES procedures for each one of the SAGE II/IV master diskettes: BUSINESS, SYSTEM, UTILITY, and BUILD.

Upon completion, you will have a full set of Working Master diskettes. One set of labels has been provided for the new diskettes. At this time you should retire the originals to a safe place, preferably away from your working diskettes. Use the working copies for your day-to-day needs.

Should you experience a failure with a Working Master, simply follow instructions on the preceding pages to make a new copy from the original.

You needn't cover the write-protect notch on your copies, as you may often wish to change some of the files or setups on your Working Master, and this requires you to "write" to the diskette.

## VII.05 CONGRATULATIONS :

Your SAGE II/IV is running, you've made backup copies of your master diskettes, and you know how to select items from the Main Menu.

### Now what?????

Before you begin to learn the specifics of an application program (such as word processing or the spreadsheet), why don't you try our demonstration program described in the following section.

It has no real value and serves no purpose. But it is fun to show friends and to dazzle small children.

After that you may head off in a number of directions. We strongly suggest that you increase your skills with the p-System as much as possible. While you may never have to use it, it is handy to know and may save you a great deal of time in certain situations.

You'll find the accompanying book, "**Personal Computing with the UCSD p-System**" to be quite helpful. It was written for microcomputers in general, so you may find some differences while using the SAGE II/IV. If you're a programmer, you'll want to spend a lot of time with this book. For those with less demanding needs, you should at least look at the sections dealing with the Command Line and the Filer.

Additionally, we've made some notes on the p-System that you might find helpful. You'll find them under p-SYSTEM PRIMER. This section deals with some of the p-System features that you will use on a regular basis, and contains some hints for novices on how to stay out of trouble.

Regardless of your primary use for a computer, word processing is an important and handy tool. Our WORD/7 package, which is bundled with each SAGE II/IV, is easy to learn and easy to use. It is accessed from the Main Menu,

BACKING-UP  
CONGRATULATIONS

and you'll find complete instructions in the rear of this manual.

You should be able to produce the majority of your correspondence with an hour or two of practice on WORD/7.

Likewise, the TIMBERLINE Spreadsheet is not difficult to use. One note is that you may use the program by simply selecting it from the SAGE Main Menu. The TIMBERLINE manual suggests that you execute "TS:SS". This will result in an error. If you do use the X(ecute command, try typing "SS". Again, it is easier to simply select TIMBERLINE Spreadsheet from the Main Menu.

The Spreadsheet is somewhat more involved than word processing, but you should have it mastered in a day or two.

Finally, if you have purchased a separate software package, such as one from State of the Art or any of the other suppliers of programs, follow their recommendations for running these applications on SAGE microcomputers.



## VIII DEMONSTRATION :

One of a computer's greatest virtues is speed. It can reduce time-consuming tasks to the blink-of-an-eye. And when it comes to "FAST", the SAGE II/IV is leading the pack. It was designed with performance in mind and has become the fastest microcomputer for its price available today.

Speed is particularly important on data intensive tasks such as mailing lists, data bases, inventory control, spreadsheets and program compilation. On many other jobs, you'll also notice a major reduction in the amount of time spent waiting for the computer to do its work.

Unless you are familiar with the characteristics of other microcomputers, you may have a hard time comparing the SAGE II/IV. The following demonstration should help. And it's fun to watch, even though it has no practical purpose.

There is an ancient Oriental puzzle known as the "Tower of Hanoi" or the "Tower of Bramah". According to legend, at the Creation, God placed 64 gold, donut-like disks onto one of three diamond needles set upright like towers. Each disk was a different size and stacked, in order, with the largest on the bottom to form a pyramid-shaped tower.

Reportedly, it was the task of a group of priests to transfer the stack to a different diamond needle. However, there was a rule that they could move only one disk at a time, AND that they could never set a large disk on top of a smaller one. Therefore, they had to use the extra peg to make interim moves.

Now, the legend says that once they completed their chore, the world would END! Even if you do believe it, there's not much reason for panic. The job requires 18,446,744,073,709,551,615 moves. In other words if they worked extremely fast, both day and night, it would still take about 600 billion years!

## DEMONSTRATION

We suspect you don't have that kind of time, but thought you might enjoy seeing the SAGE II/IV tackle a smaller tower, one with just 10 disks.

To run the DEMONSTRATION, select it from the SAGE Main Menu. Press " ← " Enter. You will see a graphic representation of the three needles, with the 10 disks stacked on the left tower. When you press any key, the moving process will begin with the SAGE II/IV trying to move the disks to the center needle. Depending on your computer set-up, the problem will run from 47 to 90 seconds. For comparison, that's 4-to-15 times faster than the other leading micros can accomplish the feat using the same programming code. Not bad!

**IX p-SYSTEM PRIMER :**

What is the p-SYSTEM and why is it on the SAGE II/IV?

As we explained earlier, a computer is little more than a mass of chips wired together until an operating system is installed to give it a purpose. When the SAGE II was in the planning stages in 1981, we searched for a suitable operating system (OS).

Building our own unique OS would have meant that there would be no software for the SAGE II. The other option was to use a popular, existing OS. There were many choices, but we decided on the p-System because it was the only OS that was highly portable.

In this context, portable means that programs developed on one machine in the p-System can be transferred to a completely different machine with very little trouble.

For the SAGE II/IV, this was an important factor. Many programmers bought SAGE's because they could develop packages using our high speed performance, and then sell those programs to users of the more popular microcomputers. Because of this feature, the bulk of the SAGE micros sold during our first year went to developers and programmers. We call these people the key influentials.

With their support, hundreds of applications have been, and are still being, written for the SAGE II/IV. Additionally, any money you invest in programs will not be wasted if you move to a different computer or perhaps some future SAGE product. Portability is the key.

Another advantage of the p-System is its menu line. Whenever you're in the OS, you'll notice that line across the top of the screen. This means that, unlike other operating systems, you needn't memorize several dozen key words or letters. All your choices are displayed where you may pick or choose. This is a wonderful feature when you're

## p-SYSTEM PRIMER

new to a computer.

The only significant disadvantage we spotted with the p-System was that it was slow. However, since the SAGE II/IV works so fast, that problem becomes insignificant.

### IX.01 USING THE p-SYSTEM :

The operating details of the p-System are contained in the book "**Personal Computing with the UCSD p-System**". Technical considerations are listed in several of the owners manual shipped with your SAGE II/IV. If you're truly interested in the details of this OS, you'll find plenty of reading material.

But for many users, the OS is of no concern. They simply want the computer to work, whether that means it runs on CP/M or PDOS or any other of the alphabet-soup OS's on the market.

If you fall in that latter category, we'll offer some brief tips here to help you learn what you need to run the computer without going into any detail. There are two topics you should understand: The p-SYSTEM MENUS and the FILER. They are described in the following pages.

Many of you will be more interested in escaping from the p-System, instead of getting into it. By that we mean that you may accidentally stumble into a feature that you didn't want by hitting a wrong key. When you become more familiar with the system that shouldn't be a problem, but for now you may like to refer to the chart on the following page. It shows how to exit any of the features on the Command Line.

## IX.02 EXITING FROM COMMAND LINE SELECTIONS :

(Note: <cr> denotes the " ← " or "ENTER" key.  
<esc> denotes the escape or "ESC" key.

YOU PRESSED: THE SCREEN SHOWS: TO RETURN TO COMMAND LINE:

E	Edit.....	<esc> <esc>
R	Compile what text...	<cr>
F	Filer: .....	q
C	Compile what text...	<cr>
L	Host file?...	<cr> <esc>
X	Execute what file?...	<cr>
A	Assemble what text?...	<cr>
D	DEBUG [x17]	q
H (SAGE II)	>	if <cr>
H (SAGE IV)	>	ih <cr>
I	System re-initialized	
U	U not allowed	
M	Monitor:.....	s

If you were using a partial, or runtime p-System, such as provided on the BUSINESS diskette, you may get slightly different messages. For example, pressing "C" will result in the message:

```
Cannot find SYSTEM.COMPIER
```

However, these types of messages will automatically return you to the Command Line.

p-SYSTEM PRIMER  
THE p-SYSTEM MENU LINE

### IX.03 THE p-SYSTEM MENU LINE :

The menu for the p-System is slightly different than the SAGE Main Menu. First it is displayed horizontally near the top of the screen. And selections are made by typing the first letter of a command. For instance, to use the C(ompiler, type "c". Likewise, you press an "f" for the F(iler.

There's another important point about the menus of the p-System. You'll notice that many of them have a question mark at the end. See the example below:

```
Command: E(edit, R(un, F(ile, C(omp, L(ink, X(ecute, A(ssem, D(ebut,?
```

That question mark after D(ebut means that there are more menu items that wouldn't fit on one line. To see the rest of the items, hold down the SHIFT key and press the "?" key.

You should now see the following menu:

```
Command: H(alt, I(nitalize, U(ser restart, M(onitor
```

This time there is no question mark. That means there are no more items. To return to the first part of the menu, just hit the "?" key again. (Don't forget that a "?" requires use of the SHIFT key.)

Some of the options on the Command: menu will take you to other sub-menus. However, they work the same way. And again, if there is a "?", there are more items off the screen.

HOWEVER, you don't have to be looking at the right line to select an item in the same menu. An example will clarify that. Suppose you're seeing the first line of the Command Menu. Even though I(nitalize is not shown, you may still press "I" and the machine will initialize.

p-SYSTEM PRIMER  
THE p-SYSTEM MENU LINE

With frequent use, you'll know which commands are on the different menus. For now, use the "?" anytime you're not sure where things are located.

As mentioned earlier, many users will never need the advanced features of the p-System. One you're certain to use is the FILER. It is explained on the following pages.

## THE p-SYSTEM FILER

### X THE p-SYSTEM FILER :

As the name implies, the p-System Filer is the File Management program. It is used to transfer, change, list, rename, condense, or examine the files. The Filer also contains a utility to set the system Date.

Regardless of your use of the SAGE II/IV, you'll want to use the Filer. We'll explain how the files are organized under the p-System in the next few pages, but first let's take a look at the Filer itself.

For the Filer examples you will need to do the following steps (if you haven't already):

SAGE II user - Insert the BUSINESS disk in Drive #4:.  
Reset the system. Type "if" to boot  
to the SAGE Main Menu.

SAGE IV user - Insert the BUSINESS disk in Drive \$4:.  
Reset the system. The machine will  
boot to the SAGE Main Menu.

Once it is on your screen, select the "p-System" option. Press <cr>. Next press "y" to confirm your choice of the "p-System". Almost immediately, you should see the Command Line as shown:

```
Command: E(edit, R(run, F(file, C(comp, L(link, X(ecute, A(ssen, D(ebug,?
```

To use the Filer functions, simply press "f". You will soon see the first line of the Filer Menu across the top of the screen:

```
Filer: G(get, S(save, W(hat, N(ew, L(dir, R(em, C(hng, T(rans, D(ate?
```

We'll explain how this menu works, but first you may use the following chart for reference in case you accidentally selected a feature from the Filer that you did not want.



## EXITING FROM FILER SELECTIONS

(Note: <cr> denotes the " ← " or "ENTER" key. <esc> denotes the "ESC" key. — denotes that no keystroke is required.)

YOU PRESSED:	THE SCREEN SHOWS:	TO RETURN TO FILER:
G	Throw away current workfile?	<cr>
S	Save as what file?	<cr>
W	not named (not saved)	--
N	Throw away current workfile?	<cr>
L	Dir listing of what vol?	<cr>
R	Remove what file?	<cr>
C	Change what file?	<cr>
T	Transfer what file?	<cr>
D	Date set <1..31>-<Jan..Dec>-<00,99> today is 25-Dec-83 New date?	<cr>
Q	Command: E(edit, R(un.....?)	f
B	Bad block scan of what vol?	<cr>
E	Dir listing of what vol?	<cr>
K	Crunch what vol?	<cr>
M	Make what file?	<cr>
P	Prefix titles by what vol?	<cr>
V	Volumes on-line:	--
X	Examine blocks on what vol?	<cr>
O	Subsidiary Volume: M(ount, D(ismount, Clear	<esc>
F	Filer segment memlocked. [xxxx words]	--

You may return to the Command Line from the Filer anytime by pressing "q" for Q(uit).

THE p-SYSTEM FILER  
p-SYSTEM FILES

**X.01 p-SYSTEM FILES :**

Let's begin the discussion by looking at how the p-System stores its files.

When the postal service sorts the mail, it starts with a large unit, the zip code, and works down to smaller units, like street, street number and name.

The p-System is accessed in a similar manner, first by Device number or Volume name, then by File name, and finally by Block.

References to Volumes and Devices are almost interchangeable, except that devices generally are related to the hardware, thus are fixed and seldom change. An example will clarify this point. The Volume name of the Business Diskette is "BUS4:". When we want to find this diskette, we can either call for BUS4:, or we can specify the diskette drive where it resides, such as #4:. If we put a different diskette, such as "ABC", into that drive, the Device name remains #4:, but the Volume name changes from BUS4: to ABC:. Note that a ":" always ends the volume name.

We'll continue the discussion of addresses in a few moments, but first we'll use the Filer to examine the Volumes or Devices that are "on-line", or available, to your SAGE II/IV.

## X.02 VOLUMES :

### V(ols

The following exercise will show you how to use the V(ols option of the Filer to examine the Volumes "on-line" for your SAGE IV.

Follow the earlier instructions on page 64 to display the SAGE Main Menu. Once it is on your screen, select the "p-System" option. Press <cr>. Next press "y" to confirm your choice of the "p-System". Almost immediately, you should see the Command Line as shown:

```
Command: E(edit, R(run, F(file, C)omp, L(link, X(ecute, A(ssen, D(ebug,?
```

To use the Filer functions, simply press "f". Soon you will see the first line of the Filer Menu across the top of the screen.

```
Filer: G(et, S(ave, W(hat, N(ew, L(dir, R(em, C(hng, T(rans, D(ate,?
```

As we discussed earlier, whenever there is a "?" at the end of a p-System Menu, there are more items off the screen. Press the "?" to display the second line of the Menu. (Don't forget to use the SHIFT key to get the "?") The screen should now display:

```
Filer: Q(uit, B(ad-blks, E(xt-dir, K(runch, M(ake, P(refix, V(ols,?
```

Again, there is a "?", meaning that there is a third line to the Filer Menu. As you did above, press the "?" to see the remaining items.

```
Filer: X(amine, Z(ero, O(n/off-line, F(lip-swap/lock
```

Notice now that there is no "?". You are at the end of the Filer Menu. Pressing the "?" will now return you to the first line. Do that now, so your screen displays the first

## THE p-SYSTEM FILER VOLUMES

line:

```
Filer: G(et, S(ave, W(hat, N(ew, L(dir, R(em, C(hng, T(rans, D(ate,?
```

Since we want to see which Volumes or Devices are "on-line", press "v" for V(ols. When you are in the Filer, you may press any of the options listed there, even if they are not visible at the top of the screen. The V(ols is actually on the second line of the Filer:

Once you have pressed "v" you should see:

```
Filer: G(et, S(ave, W(hat, N(ew, L(dir, R(em, C(hng, T(rans, D(ate,?
```

```
Vols on line:
1  CONSOLE:
2  SYSTEM:
4 #  BUS4:  [1280]
5 #  DOC1B: [1280]
6  PRINTER:
7  REMIN:
8  REMOUT:
11 # RAMDISK:
    Root Vol is - BUS4:
    Prefix is  - BUS4:
```

Your screen may appear slightly different. You may not have a #5:, for instance. You may have more device numbers, or fewer, depending on the model of SAGE microcomputer you are using.

The V(ols command from the Filer is useful in determining what is or is not "on-line". For example, if you can't get a diskette to work, you might see if it is listed in the V(ols. If you had placed a diskette in Drive #4:, but the V(ols did not show it, you have some sort of a problem. The V(ols option is also handy to make sure the right diskette is where you want it.

### X.03 PREFIX :

#### P(refix

At the bottom of the V(ols listing are the words, "Prefix is -". You'll recall from our discussion of how the SAGE II/IV finds files and diskettes that the prefix allows you to call for a file without having to list the Volume Name each time.

For example, suppose we wanted to X(ecute the file known as WORD7. Also assume that the file "WORD7" is on the diskette volume named BUS4:. Since our V(ols Listing told us that the Prefix is already BUS4:, to execute the file, we would simply type X(ecute from the p-System command line and then respond with "WORD7" to the query "Execute what file?".

If the Prefix were set to something different, we would have to type the Volume Name as well as the File Name. Thus, if the Prefix were SAGE:, and we wanted to execute WORD7 from the diskette named BUS4, we would have to type the full name, "BUS4:WORD7", when the machine asked "Execute what file?":

In summary, the Prefix saves us time by automatically indicating the Volume Name. It's as though you bought mailing envelopes that already had the City and State imprinted on the address line. You would only have to type in the name and the street address.

When you boot your SAGE IV to the operating system, the Prefix is automatically set to the name of the Boot Volume, (also known as Root Volume). What if you want to change it? That is also quite easy and is part of the Filer Menu.

If the Filer Menu is on your screen, simply press "p" for the P(refix option.

If you are not in Filer:, follow the directions listed under "The Filer" on page 64 ; then press "p".

## THE p-SYSTEM FILER PREFIX

Once you've pressed "p", you should see the following:

```
Prefix titles by what vol ?
```

Now type in the letters "abc". You should see the following message:

```
File: G(et, S(ave, .....R(em, C(hng, T(rans, D(ate, ?  
BUS4: ABC - File not found, Vol name expected <source>
```

This message indicates that you did not type a correct Prefix name. All prefix names must have a ":" at the end and have seven or less characters. Let's try it again.

Type "p". When the message, "Prefix titles by what vol", appears, type "abc:".

The screen should now read:

```
File: G(et, S(ave, .....R(em, C(hng, T(rans, D(ate,?  
Prefix is ABC:
```

You can verify that you have changed the Prefix by selecting V(ols. It should now indicate that the Prefix is - ABC:.

Follow the procedures above to change the Prefix back to BUS4:

#### X.04 LISTING THE FILES :

##### L(dir

The next division in size below the Volume name or Device number is the File. Files may contain either Code which is a compiled program or Text which might be a program or document or raw Data which might be used to prepare the payroll or financial reports.

We can use the Filer to see just what files are stored on each Volume, when they were stored, how big they are, and what type of material they contain. This listing of the files is also known as a Directory. To locate files, the SAGE II/IV consults it like a Table of Contents. We'll show you two different ways to list, or display, the Directory.

From the Filer Menu, (see page 64 ), press "l" ( that's a small L, not a 'one') for L(dir. You should now see the following message:

Dir listing of what volume ?

Type "bus4:". Press <cr>.

You should now see a screen similar to the one shown:

# THE p-SYSTEM FILER

## LISTING THE FILES

Type <space> to continue

BUS4:

SYSTEM.PASCAL	126	22-Dec-82
SYSTEM.MISCINFO	1	17-Mar-83
USERLIB.TEXT	4	8-Aug-83
SYSTEM.LIBRARY	7	13-Sep-82
SYSTEM.FILER	39	27-Aug-82
SYSTEM.EDITOR	50	14-Oct-82
SAGE4UTIL.CODE	67	5-Aug-83
ENDBOOT	1	13-Sep-82
SYSTEM.BIOS	33	21-Sep-82
SYSTEM.INTREP	23	24-Sep-82
WORD7.CODE	147	17-Sep-83
TS.CODE	184	22-Mar-83
TS.SPEC	1	22-Mar-83
SCREENOPS.CODE	8	16-Jun-83
SYSTEM.STARTUP	13	21-Sep-83
HDEMO.CODE	5	20-Dec-82
SS.CODE	146	22-Mar-83



THE p-SYSTEM FILER  
LISTING THE FILES

Your screen may be different than the one shown, but it should be similar. If the Filer Menu is displayed at the top of the listing, you are looking at all the files on the designated Volume. If you see the "Type <space> to continue" message, there are files that would not fit on one screen. To see them, simply press the space bar. When the Filer Menu appears, there are no more files on the Volume.

Notice the title, "BUS4:" just above the example. This indicates the Volume name of the files you've listed.

Below that are the files themselves. The first item in the line is the name of the file. For example, "SYSTEM.PASCAL" is the name of the first file in our listing. The next item in the line is the number of blocks that this file occupies. In the example we've shown above, SYSTEM.PASCAL uses 126 blocks. The final item in the line is the date the file was last changed. In our example, SYSTEM.PASCAL was last changed on December 22, 1982.

When you reach the last file on the volume, you'll notice a notation similar to the one below:

```
31/31 files<listed/in-dir>, 985 blocks used, 295 unused, 295 in largest
```

If you do not see such a line at the bottom of your listing, press the space bar( <space> ) until such a line appears (and the Filer Menu is again at the top of the screen).

This line is a summary of the Volume. It tells how many files are listed and in the directory, the number of blocks used, and the number unused. With this information you can see how large a particular file is or determine if another file will fit on your diskette.

THE p-SYSTEM FILER  
LISTING THE FILES

● EXTENDED DIRECTORY

E(xt-dir

The Extended Directory is similar to the L(dir, but more information is displayed. Using the "E" option, instead of the "L" option, from the Filer Menu, (see page 64 ), will result in a slightly different listing.

Here are some sample lines from an Extended Directory:

SYSTEM.PASCAL	126	22-Dec-82	6	512	Datafile
USERLIB.TEXT	4	8-Aug-83	133	512	Textfile
SYSTEM.EDITOR	50	14-Oct-82	183	512	Codefile
TS.SPEC	1	22-Mar-83	513	434	Datafile

Notice that two additional items are listed here that were not on the Directory Listing. The column following the date refers to the beginning location of the file within the directory. SYSTEM.PASCAL begins at block 6. SYSTEM.EDITOR begins at block 183, and so on.

The number 512 in the next column relates to the last byte filled in the last block used. Each block on our files has 512 bytes. So SYSTEM.PASCAL used all the bytes available in the last block it occupied. However, the file TS.SPEC used only 434 bytes of the last block.

The last item in the line describes the type of file listed. In our example, SYSTEM.PASCAL is a file containing DATA. USERLIB.TEXT is a file containing TEXT. And SYSTEM.EDITOR is a file that contains a compiled program or program code.

Much of this information is of interest only to programmers or developers, but feel free to use either the "L" or "E" options from the Filer. There is no penalty in seeing the Extended Directory Listing versus the shorter Directory Listing.

## X.05 TRANSFERRING FILES :

### T(rans

One of the most useful options from the Filer will be T(rans or TRANSFER. This is used to move files from one Volume to another Volume. Transfer will also move files from one device to another. For example, you could move a file from diskette drive #4: to the Printer: or the Console: (Terminal Screen).

When you originally made backup copies of your SYSTEM diskettes, we used the Transfer function. However, in that case, we transferred the entire contents of the diskette to another diskette. Now we'll talk about how to transfer single files.

So you needn't use a new diskette, in our example we'll transfer a file from the BUSINESS Diskette right back onto the BUSINESS Diskette, but we will give it a different name. The procedure is exactly the same if you transfer it to a different diskette or device.

Check that the Filer Menu is displayed at the top of the screen (See page 64) Press "t" for Transfer. You should see the message:

```
Transfer what file ?
```

Type the following: bus4:qstart.text

Press <cr>. You should see this message:

```
Transfer what file ? bus4:qstart.text  
To where ?
```

Type the following: bus4: xxx.text

Press <cr> You should see this message:

## THE p-SYSTEM FILER TRANSFERRING FILES

```
BUS4:USERLIB.TEXT - -> BUS4:XXX.TEXT
```

This message indicates that the transfer has occurred successfully. If you perform a directory listing (L(dir), you'll see that BUS4: now includes the file XXX.TEXT.

You'll notice that we included both the volume name and the file name to make our transfers. We could have also used the Device number to achieve the same results. For instance, #4:qstart.text would have done the same thing if QSTART.TEXT was in the #4 Diskette Drive.

Likewise, if you want to make a transfer to another diskette, and have a machine with two drives, you will use the Device number when asked "To where ?", as shown below.

```
Transfer what file ? bus4:qstart.text  
To where ? #5:xxx.text
```

When you transfer a File to another Volume , you can use the same File name. Here's an example of the entries to transfer the file:

```
Transfer what file ? bus4:qstart.text  
To where ? #5:qstart.text
```

If you have a spare diskette, you may like to try a real transfer. For the SAGE II the entries would be as shown above. For those with a SAGE IV, use the example below:

```
Transfer what file ? sys:qstart.text  
To where ? #4:qstart.text
```

There are many shortcuts you can learn as you become more familiar with the p-System and the Filer, but to insure success, remember to always include the Volume name or Device number and the File name of the File to be transferred. For the destination (To where?) also include the Volume name or Device number and the File name.

**X.06 CHANGE :**

**C(hng**

You may want to change the name of a File or Directory to make it easier to recognize. To do so is a simple matter. Press "c" and this message is displayed:

```
Change what file?
```

To change a File name, type the Volume name or the Device number followed by the File name. When you do, the screen will look like this:

```
Change what file? #4:xxx.text  
Change to what? #4:notes.jfk.text
```

If you list the directory, you will find that notes.jfk.text is listed and xxx.text is no longer there.

You can change the name of a Directory in the same fashion. Press "c" to obtain the message:

```
Change what file?
```

Type just the Volume name or Device number and the screen will look like this:

```
Change what file? #4:?  
Change to what? LETTERS:
```

When you now list the directory--L(dir), you will see that LETTERS: is now the Volume name. Now use C(hng to restore the name of the volume. The BUSINESS disk was named BUS4:.

More details on this and other Filer functions are explained

THE p-SYSTEM FILER  
REMOVE

in "Personal Computing with the UCSD p-System" .

**X.07 REMOVE :**

**R(em**

The Filer R(emove option is used to delete individual Files you no longer need. As in T(ransfer, this procedure requires you to indicate the Volume Name or Device Number and the File name.

When you press "r" to R(emove a File, you'll see:

```
Remove what file?
```

Type "#4:notes.jfk.text" and the screen will look like this:

```
Remove what file ? #4:notes.jfk.text
BUS4:NOTES.JFK.TEXT      --> removed
Update directory?
```

If you answer "n" to the Update directory question, the file will not be removed. This gives you a chance to reconsider your decision and is a safeguard against losing a File you might need. An answer of "y" will remove the File called notes.jfk.text and update the directory. Go ahead and type "y".

Again, more details on this and other Filer functions are explained in "Personal Computing with the UCSD p-System".

## X.08 WILDCARDS :

There are many shortcuts contained in the p-System that help you save time. One of the most convenient is the use of special characters called "Wildcards". We'll show you one and refer you to the p-System books to learn about the many others.

When performing the Transfer option, we discussed moving a file from one place to another. That required you to type the name of the file twice as shown below:

```
Transfer what file ? bus4:qstart.text  
To where ? #5:qstart.text
```

The "\$" is a wildcard that means "same name". For example, to transfer the file above we could have saved some typing by making this entry:

```
Transfer what file ? bus4:qstart.text  
To where ? #5:$
```

This transfers the QSTART.TEXT file to #5, but it saves typing the File name again. You'll find the other wildcards equally helpful. If you will be using the p-System a lot in your applications, we encourage you to become familiar with all the wildcards.

## SYSTEM BASICS

### XI SYSTEM BASICS :

At this point a little background on various features of the SAGE is in order. These features are referred to throughout the rest of the manual and described in detail in the SAGE II/IV TECHNICAL MANUAL.

#### RAM

RAM stands for Random Access Memory. Most of the SAGE computer's memory is RAM. Information stored in RAM goes away if the power to the system is shut off. However, information can be read and written to RAM much faster than any other device on a computer. Programs are "loaded" ( copied ) from a disk or floppy into RAM where they are executed, that is they "run" in RAM.

#### RAM DISK

Since RAM is the fastest device on the system, and since the SAGE can have up to 1 Megabyte of RAM, it may make sense to take part of the RAM and make it look like a fast disk. This is called RAM DISK. Programmers especially like to use RAM DISK for development. Programs compile much faster from RAM DISK allowing the developer to produce more programs in less time.

RAM DISK is an option that can be specified by SAGEUTIL or by MU.UTIL if you have a SAGE Multi-user system.

#### SINGLE-USER

A person who is using the entire resources of the machine is generally a "single-user". The "In the Beginning" sections dealt with single-user operation on the SAGE.

#### MULTI-USER

The SAGE computers can have up to six users at one time. This is the "Multi-User" system. A custom configuration can be "installed" by a knowledgeable person or one of the standard configurations can be used. Only one person can use the machine unless the Multi-User system is installed.



### CONFIGURATION

The term "Configure" is one you will see a lot of in the SAGE manuals. It means to set up the software and hardware options of the machine. For example, several Multi-User systems have already been "configured" for you and are available on the BUILD diskette. See page 195.

### PARTITIONS

The SAGE computers support hard disk with up to 40 Megabytes of storage. The hard disk is usually divided up into smaller areas called "partitions" and assigned to different jobs or to different users. The SAGE II/IV TECHNICAL MANUAL has specific information on how you can configure partitions on your disk. The standard Multi-User systems have the disk partitions already built into them.

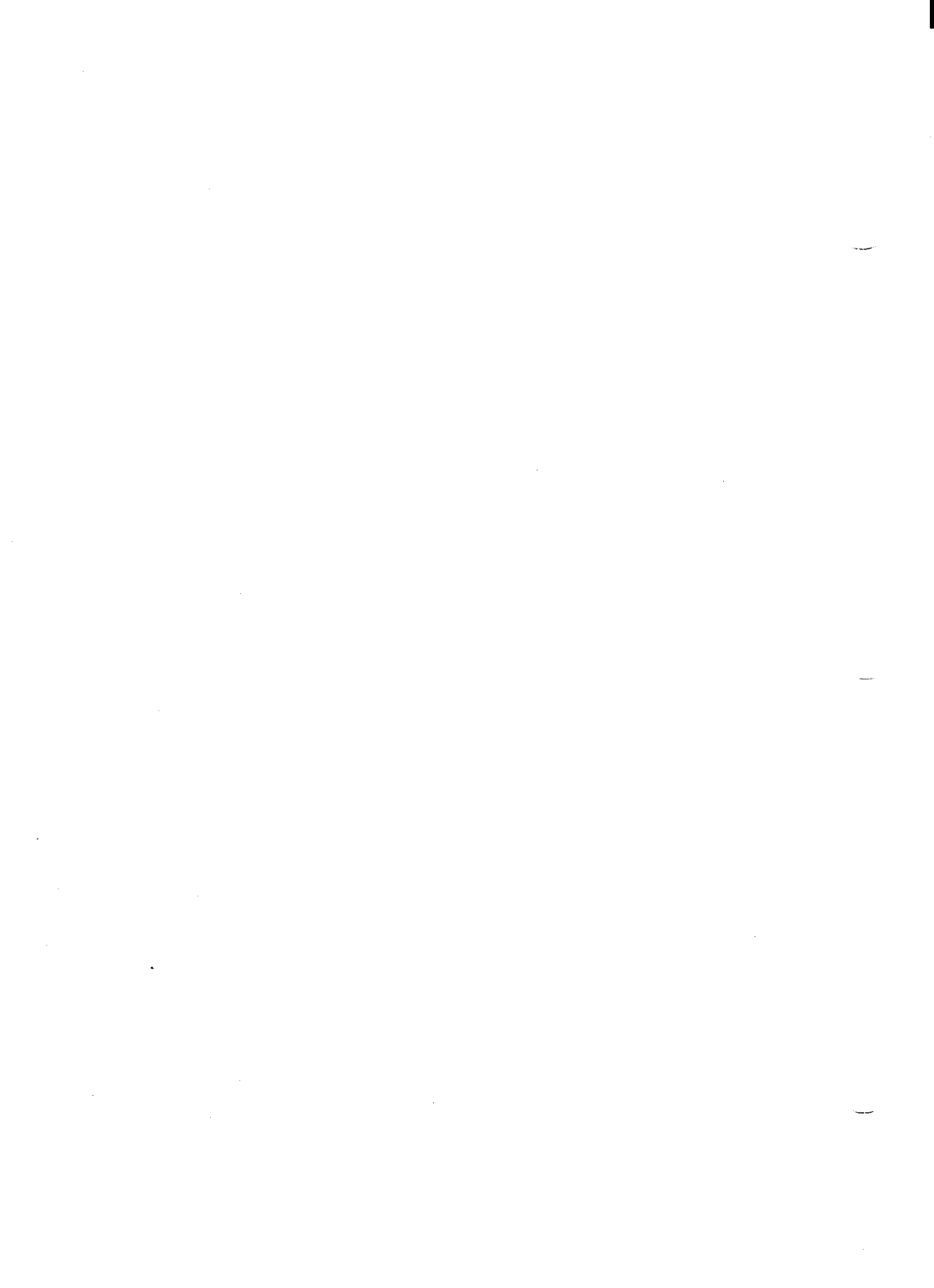

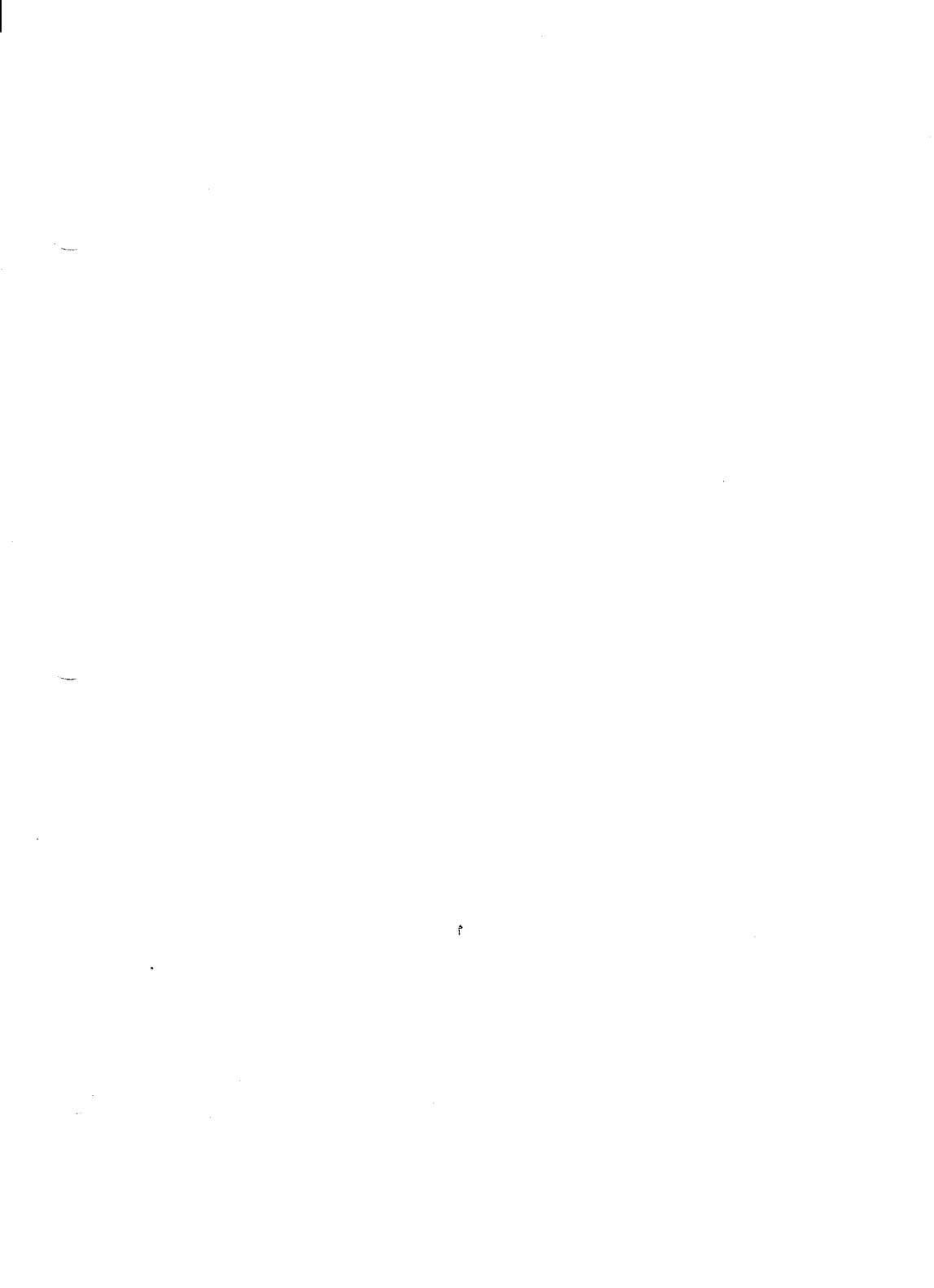

## P--SYSTEM TERMINAL CONFIGURATION

### XIII P--SYSTEM TERMINAL CONFIGURATION :

Unless you have ordered your terminal from SAGE, you will have to give the p--SYSTEM information on what kind of terminal you have. This is called "installing" the terminal. This process may be very easy or somewhat difficult depending on the type of terminal you have. This section describes all the steps that may be necessary for you to install your terminal. If you have a QUME QVT102, TELEVIDEO TV925, or FREEDOM 100 turn to the section on BUSINESS MASTER TERMINALS.

#### XIII.01 COMMUNICATION PARAMETERS :

In order for your SAGE computer to start up properly, the terminal and computer must be set to talk at the same speed. This is called the "communication rate" or the "baud rate". (Baud stands for the number of bits per second which can be sent and is named for the French inventor J.M.E. Baudot.)

Check the figure on the next page to see how the switches for the computer are set. They must be set to the same baud rate as your terminal. Your terminal manual will show you how to set up the terminal baud rate. Sometimes there are switches on the back of the terminal. Some newer types of terminals let you type in the parameters using a special "mode". You get into this mode by typing one of the keys usually marked "SET UP" or "LOCAL". An example of how the SAGE terminal does this is given in the section called "CONFIGURING THE TERMINAL" in this manual on page 10.

Other parameters such as parity, the number of data bits, and the number of stop bits must be set to match on both the computer and the terminal end. As long as the parameter settings match, you should be able to start your computer. The SAGE terminal uses:

19.2K baud                   (Use 9600 for most others)  
8 bits of data  
1 stop bit  
parity disabled

P-SYSTEM TERMINAL CONFIGURATION  
COMMUNICATION PARAMETERS

XON/XOFF on

Note that if parity is enabled, you must also define it as even.

The standard switch settings for the computer are shown below.

SAGE II

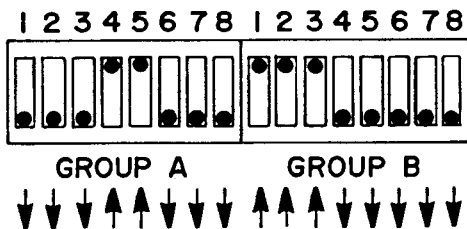

SAGE IV

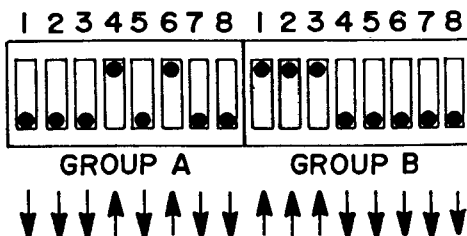

*Lw*

P-SYSTEM TERMINAL CONFIGURATION  
TERMINAL CABLES

**XIII.02 TERMINAL CABLES :**

The kind of cable needed depends on where you physically connect the terminal to the SAGE II/IV. Terminals can be connected to:

1. The main terminal port. This is most common.
2. One of the auxiliary ports for a multi-user system. This cable is usually the same as 1 above.
3. The remote, or modem port. Usually only on a multi-user system.

All of these cables must have an RS232 connector on the SAGE end. RS232 serial asynchronous transmission is the kind of protocol used by most microcomputers to talk to terminals. It is so common that you should be able to buy the appropriate parts at your local hardware store if you are going to the trouble of making your own cable. It is, however, usually easier to buy the cable you need.

Notice that while "RS232" is standard on almost every terminal and computer, there are options in how the terminal can be connected. This is why you should not use a cable built for another computer without checking the wiring. You can damage the computer with the wrong cable.

What kind of cable do you need? The following pages show the wiring and SAGE Part number for these cables:

1. Standard cable for the TERMINAL port and AUX ports. Works for both Single User and Multi-user. For the Qume QVT102 and most others.
2. Standard cable for REMOTE port. Usually used in Multi-user mode.

If one of these two cables does not work, you must study the section on RS232 communication to figure out how your terminal differs. Remember that the problem is usually not the cable at all, but that you have not properly set the COMMUNICATION PARAMETERS such as BAUD RATE, PARITY etc.

P-SYSTEM TERMINAL CONFIGURATION  
TERMINAL CABLES

● STANDARD TERMINAL CABLE

Below is the wiring and SAGE part numbers for the standard cable for the TERMINAL port and AUX ports. This cable should work for both Single User and Multi-user modes for most terminals.

SAGE PN#	LENGTH	
CC0056A	10ft	(all are 5 connector cable)
CC0057A	25ft	
CC0079A	50ft	
CC0058A	100ft	
CC0080A	200ft	

SAGE	WIRE COLOR	TERMINAL
1---470-----	BROWN-----	→ 1
2---470-----	BLACK-----	→ 2
3---470-----	RED-----	→ 3
4-->9		
7---470-----	GREEN-----	→ 7

|  
470 Ohm resistor

AUX-470 is marked on the SAGE II/IV end of the cable.  
TERMINAL is marked on the terminal end.  
Dummy pins are inserted in positions 13, 14, 25.  
This cable has a 470 ohm resistor in series with each wire in the connector at the SAGE II/IV end.

P-SYSTEM TERMINAL CONFIGURATION  
TERMINAL CABLES

● STANDARD REMOTE TERMINAL CABLE

The REMOTE port is slightly different from the other TERMINAL ports since it is usually intended for use with a MODEM and not a TERMINAL. However, with the proper cable as shown below, a terminal will work very well. Most installations leave the REMOTE port free for use with a MODEM or printer unless they are running 6 users. (Note that this cable may not work for talking to a printer or MODEM.)

SAGE PN#	LENGTH
CC0038C	10ft (5-cond wire)
CC0039C	25ft
CC0077C	50ft
CC0040C	100ft
CC0078C	200ft

SAGE	WIRE COLOR	TERMINAL
1---470-----	BROWN-----	> 1
2---470-----	BLACK-----	> 3
3---470-----	RED-----	> 2
4-->6-->9		
7---470-----	GREEN-----	> 7

|  
470 Ohm resistor

Remote-470 is marked on the SAGE II/IV end of the cable. TERMINAL is marked on the terminal end. Dummy pins are inserted in positions 13,14,25. This cable has a 470 ohm resistor in series with each wire in the connector at the SAGE II/IV end.



● BUILDING A TERMINAL CABLE

If your terminal has options that require a different cable, this section may be of help to you. If some of the terms used in this section are unfamiliar to you, we suggest that you buy a reference book for RS232 communications.

"RS232 MADE EASY" by Martin D. Seyer  
"DATA COMMUNICATIONS HANDBOOK" Signetics Corporation  
"DATA COMMUNICATIONS, A USER'S HANDBOOK" Racal Vadic

Also see the section in this manual called RS232 PROTOCOL on the next page.

This TERMINAL port operates as RS232 Data Communication Equipment at software definable speeds from 50 - 19.2K baud in either interrupt-driven or polled mode. GROUP-A DIP switches on the back panel define the initial baud rate. The DB-25 connector is located at the rear of the machine and is marked "TERMINAL". Pin-outs for the signals are:

PIN#	1	Protective Ground
	2	Transmitted data (from terminal) <---
	3	Received data (to terminal) --->
	5	Clear-to-send (to terminal) --->
	7	Signal Ground
	9	+12 VDC
	10	-12 VDC
	11	+ 5 VDC

Compare these signals to the pin-outs given for your terminal. The terminal manual should also show the normal cable connection for that terminal.

Note that this port is normally configured for 19.2K baud with parity disabled, 8 bits of data, 1 stop bit and XON/XOFF on. This can be changed using the switches on the back of the SAGE™ II/IV.

P-SYSTEM TERMINAL CONFIGURATION  
TERMINAL CABLES

CTS and DSR are explained in the section on TERMINAL PORT  
OPTIONS.

**XIII.03 RS232 PROTOCOL :**

There always seems to be a lot of confusion involving the interconnection of serial devices using the RS232 protocol. This section is provided to clarify the hardware protocol and terminology. Software configuration and conventions are covered in the section describing SAGE4UTIL, SAGE's configuration and utility program.

The RS232 standard was developed for the typical timesharing scenario where a terminal is connected through a pair of modems to a computer. The terminal and the computer are referred to as Data Terminal Equipment (DTE) and the modems are referred to as Data Communications Equipment (DCE).

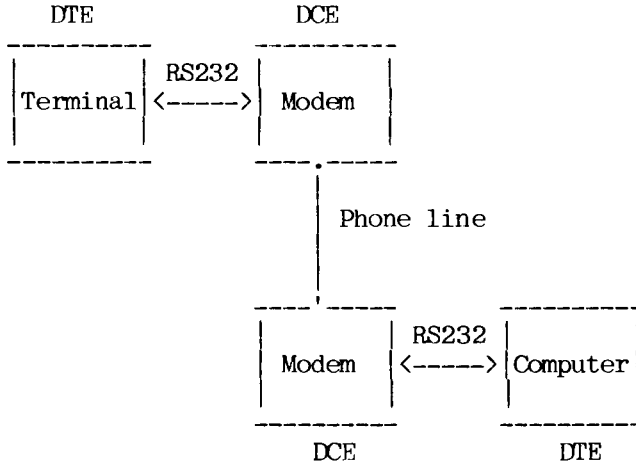

P-SYSTEM TERMINAL CONFIGURATION  
RS232 PROTOCOL

A large source of the confusion comes from the fact that the signal names are from the perspective of the Data Terminal Equipment. The following diagram shows the relationship of the typically used RS232 signals.

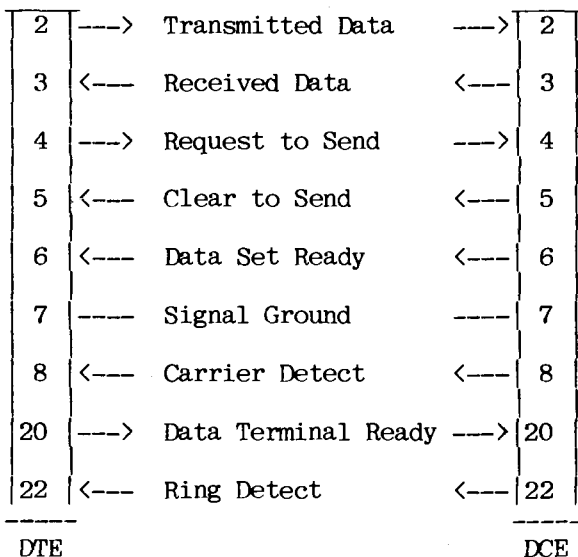

Notice that for the Data Communications Equipment connector, pin 2 is called Transmitted Data but the signal is actually an input to the device. Therefore, in order to know the direction of the signal, it is important to know if the device is considered Data Terminal Equipment or Data Communications Equipment. Conversely, if the signal direction is known, it will be possible to determine if the device is considered Data Terminal Equipment or Data Communications Equipment.

P-SYSTEM TERMINAL CONFIGURATION  
RS232 PROTOCOL

A second complication arises because, in the typical microcomputer application, the terminal is connected directly to the computer without going through a set of modems. If the computer is considered Data Terminal Equipment this requires connecting two DTE devices back to back. To do this the signal lines on pins 2 and 3 must be cross connected with a non standard cable.

The **SAGE II/IV terminal port** has therefore been set up as **Data Communications Equipment** in order to allow a standard cable to interconnect the computer to a Terminal. If the SAGE II/IV terminal port is to be connected to a modem, then a special cable cross connecting pins 2 and 3 will be required. Notice that, because the SAGE II/IV terminal port is considered Data Communications Equipment, the Transmitted Data signal is an input and the Received Data signal is an output.

The **SAGE II/IV modem port** (Remote serial channel) is set up as **Data Terminal Equipment** to easily connect to a modem (DCE) with a standard cable. If the modem port is to be connected to a printer, a special cable will probably be required to interconnect two Data Terminal Equipment devices (cross connecting pins 2 & 3).

Another source of confusion is the signal levels on the RS232 lines. For the Transmitted Data and Received Data lines, a logic 0 level (called the Space state) is represented by a positive voltage between 3 and 25 Volts. A logic 1 level (called the Mark state) is represented by a negative voltage between - 3 and - 25 Volts. An idle data circuit will stay in the logic 1 (Mark) state. All of the other RS232 control signals have the opposite signal level. An active Clear to Send (logic 1) is represented by a positive voltage between 3 and 25 Volts.

P-SYSTEM TERMINAL CONFIGURATION  
Terminal XON/XOFF

**XIII.04 Terminal XON/XOFF :**

Some terminals cannot keep up with handling certain functions when receiving information at a high baud rate. Many terminals have an XON/XOFF protocol which allow them to tell the computer when to stop sending and when to continue sending.

The SAGE p-System is normally shipped with XON/XOFF enabled. The p-System does not define a START character. However when XON/XOFF protocol is being used, a CTRL Q (XON) must be used to start the terminal instead of the CTRL S toggle. If this option is unnecessary, the configuration utility routine SAGE4UTIL.CODE should be used to turn off the Terminal Option for XON/XOFF.

Note also that the p-System STOP character must be defined as CTRL/S (XOFF). This is the normal assignment but it may have been modified with SETUP. Also the XON/XOFF protocol is normally a terminal option and may have to be enabled in the terminal.

● TERMINAL PORT OPTIONS

The CTS (Clear to Send) function is normally always held high (+12V). To change this remove the SAGE cover and find the strap (S06) near the terminal connector at the rear corner of the board.

The strap is normally set so that CTS is held high. To drive CTS, the strap from [A] must be cut:

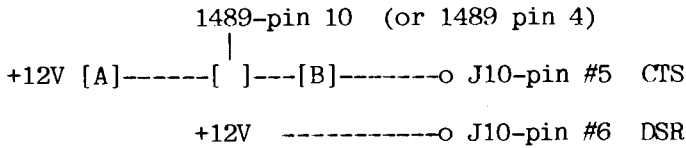

Note: Circuit boards issue CB002 are connected differently as shown below. To drive CTS, cut the trace from pin 6 to pin 5. Cut the trace from [B] to pin 6. Rewire pin 5 to [B]. Also cut +12V from pin 6 and connect pin 6 to U59-1.

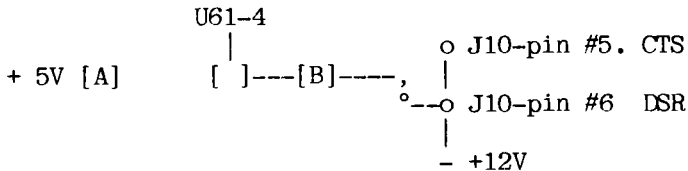

P-SYSTEM TERMINAL CONFIGURATION  
BUSINESS MASTER TERMINALS

**XIII.05 BUSINESS MASTER TERMINALS :**

The business master is distributed configured for the Qume QVT102 terminal. However, it can be easily changed to operate with either a TV925 or the Freedom 100 using a SCRIPT file available on the diskette.

In order to change terminals on the BUSINESS MASTER:

1. BOOT TO THE BUSINESS MASTER. You should be at the MENU.
2. SELECT THE p-SYSTEM OPTION by moving the cursor in front of it and typing <cr>, (The RETURN key). You should now be at the p-System command line.
3. EXECUTE THE SCRIPT FILE FOR THE NEW TERMINAL:

"X TRM.SCRIPT"

A menu of terminals will display. Choose your terminal. You will see various commands go by on your screen. When the SCRIPT file is finished, you will be back at the p-SYSTEM command line. Your terminal files are now installed.

4. Type "I" or "i" to get back to the MENU.

**TECHNICAL NOTE:** The SCRIPTs rename various files on the disk so that SYSTEM.MISCINFO, WORD7 and the Spreadsheet are also properly set up for the new terminal. Because all three of the terminals use the same GOTOXY file (GOTOXY will be described in a later section, you can still boot the BUSINESS disk and use the QVT102 configuration while changing to one of the other terminals. (TV925 or F100 terminals.)



**XIV BUILD A USER MASTER :**

If your terminal needs a different configuration than the three (Qume QVT102, TV925 and Free100) supplied on the BUSINESS MASTER, you should build a USER MASTER diskette to work from. Even if you have a hard disk system you should build a diskette to serve as your archive master.

The following procedure expects the user to have a work area called SCRATCH:. For a SAGE II user, this will be a floppy in drive #4:. For a SAGE IV user, this will be volume #10: on the hard disk. The example will work for both users in exactly the same way if the following is done:

SAGE II : Format and Zero a diskette naming it SCRATCH:  
SAGE IV : Format and Zero a diskette naming it NEW:

Refer to pages 38 and 45 for help in doing this.

The next sections will cover in detail how to do each of the following necessary steps:

- 1) Load the BOOT program on the diskette.
- 2) Create/load the terminal's SYSTEM.MISCINFO
- 3) Create/load the terminal's GOTOXY
- 4) Transfer the system files.

BUILD A USER MASTER  
VANILLA BOOT

**XIV.01 VANILLA BOOT :**

You should start-up your system using the "vanilla" SYSTEM MASTER. It is called "vanilla" because there are no special terminal functions, that is, no chocolate, no cherry etc. The BUSINESS MASTER, on the other hand is flavored for a SAGE (QUME QIV102) terminal. The SYSTEM MASTER has been specially created to help bring up various types of terminals.

The following procedure treats the hard disk system and the floppy based system in the same way. The only difference is that a SAGE IV system having only one floppy drive will use the SCRATCH: area on the hard disk instead of the second (#5:) floppy drive.

- 1) Set switches 5 and 6 of GROUPA on the back of the system DOWN.
- 2) Reset (or power-up) the system. Insert the SYSTEM MASTER diskette.
- 3) Type "IF" to boot to the SYSTEM MASTER.

At this point you should have booted from the SYSTEM MASTER diskette in drive #4: and the p-SYSTEM command line should be on the screen:

Command: E(edit, R(un, F(ile, C(omp, L(ink, X(ecute, A(ssem, D(ebug?

#### XIV.02 LOADING BOOTSTRAP :

Next you must copy the floppy bootstrap program to the USER MASTER.

The bootstrap program must reside on any diskette or partition which "boots" or starts the p-System operating system. Data diskettes or partitions do not need it. If you try to start the computer using a diskette or partition that does not have the boot program, you will get an error:

```
NOT BOOT DISK
```

Note that there are several bootstrap programs depending on what kind of system you are building:

```
SAGE.PBOOT.CODE -single user floppy boot to p-System
SAGE.WBOOT.CODE -single user Winchester boot to p-System
MU.FBOOT.CODE   -Multi-user BIOS floppy boot
MU.WBOOT.CODE   -Multi-user BIOS Winchester boot
MU.PBOOT.CODE   -Multi-user boot to p-System
```

Here we are building a floppy diskette on a single-user system so the file needed is SAGE.PBOOT.CODE. The process is nearly identical for any flavor of system being built, only the file name and volume will be different.

BUILD A USER MASTER  
LOADING BOOTSTRAP

EXAMPLE: Use SAGE4UTIL to copy the floppy boot from the SYSTEM MASTER to your SCRATCH: area. (SCRATCH will eventually become the USER MASTER.)

```
THE SCREEN SHOWS:                                YOU TYPE:
Command: E(edit,R(un,F(ile..... X
Execute what file?                SAGE4UTIL <cr>

SAGE4UTIL version 1.3
Initializing....

      SAGE4UTIL
A On-line Configuration
B BIOS file Configuration
C Floppy Formatter
D Bootstrap copy
E Prepares Drives for shipping

Select menu item <cr exits, !aborts>:
Select bootstrap Copy Utility..... D
Source file or device <just CR quits>?... SAGE.PBOOT.CODE
Ready to load bootstrap from file..... Y
Bootstrap of 1008 bytes read successfully
Destination file or device<just CR quits>? SCRATCH:
Ready to load bootstrap on volume #5?.... Y
Bootstrap data written successfully
Type <space> to continue..... <space>
Select menu item <cr exits, !aborts>:..... <cr>
```

You are now back at the p-System command line. The SCRATCH: volume now has a Bootstrap program on it.

#### XIV.03 SYSTEM.MISCINFO INSTALLATION :

SYSTEM.MISCINFO is a file used by the p-System operating system which contains "miscellaneous" information about the terminal and various system parameters. It must hold the correct information for your terminal or your application programs will not run properly.

A "vanilla" SYSTEM.MISCINFO is shipped on the SYSTEM MASTER disk. Hopefully, this uncomplicated definition will work well enough with your terminal at first to let you build a good SYSTEM.MISCINFO for normal use.

SYSTEM.MISCINFO is maintained by using a program called SETUP.CODE which is available on your SYSTEM MASTER disk. As typing in all of the options for SETUP.CODE takes some time, SAGE has proved MISCINFO files for many of the terminals now sold. If your terminal is NOT one of those on the following list or cannot emulate one of them, then you must skip the following step and go to the next section which discusses SETUP.CODE.

BUILD A USER MASTER  
SYSTEM.MISCINFO INSTALLATION

● SYSTEM.MISCINFO FILES

The following files are shipped on either the SYSTEM MASTER or UTILITY MASTER diskette.

Terminal:	Change file to SYSTEM.MISCINFO	Install GOTOXY in SYSTEM.PASCAL
QUME QVT102	QVT102.MISCINFO	TV925.GOTO.CODE
TeleVideo 925/950	TV925.MISCINFO	TV925.GOTO.CODE
TeleVideo 912C/920C	TV912.MISCINFO	TV925.GOTO.CODE
Heath H19	H19.MISCINFO	VT52.GOTO.CODE
SOROC IQ120	IQ120.MISCINFO	TV925.GOTO.CODE
Hazeltine 1500	HZ1500.MISCINFO	H1500.GOTO.CODE
ADDS Regent 25	RG25.MISCINFO	VT52.GOTO.CODE
ADDS Viewpoint 60	ADDS60.MISCINFO	VT52.GOTO.CODE
ADM3A	ADM3A.MISCINFO	TV925.GOTO.CODE
Freedom 100	FD100.MISCINFO	TV925.GOTO.CODE
DEC VT52	VT52.MISCINFO	VT52.GOTO.CODE
VISUAL 550 in VT52 emulation with 33 lines	VIS52.MISCINFO	VIS52.GOTO.CODE
VISUAL 550 (33 lines)	V550.MISCINFO	V550.GOTO.CODE
ANSI Standard Term (DEC VT100 series)	ANSI.MISCINFO	ANSIGOTOXY.CODE

Note that for ANSI terminals ANSI.CODE must be installed in SYSTEM.PASCAL to replace the existing SCREENOPS routines.

BUILD A USER MASTER  
SYSTEM.MISCINFO INSTALLATION

If your terminal is one of those shown in the previous list, use the FILER to transfer the correct MISCINFO file to the new disk.

EXAMPLE: Installing the correct miscinfo for the Hazeltine 1500.

THE SCREEN SHOWS:	YOU TYPE:
Command: E(dit,R(un,F(ile....	F
File:.....	T
Transfer what file?.....	H1500.MISCINFO <cr>
To where?.....	SCRATCH:SYSTEM.MISCINFO <cr>

BUILD A USER MASTER  
SYSTEM.MISCINFO INSTALLATION

● **KEYBOARD assignments**

The MISCINFO files listed previously define the following functions to the various terminal keyboards as follows.

Terminals:	QUME QVT102 (SAGE Terminal)
EDITOR ACCEPT KEY	Ctrl C
EDITOR ESCAPE KEY	ESC
EDITOR EXCHANGE-DELETE KEY	Ctrl D
EDITOR EXCHANGE-INSERT KEY	Ctrl E
KEY FOR BREAK	Ctrl @
KEY FOR FLUSH	Ctrl X
KEY FOR STOP	Ctrl S
KEY TO ALPHA LOCK	Ctrl R
KEY TO DELETE CHARACTER	BACKSPACE
KEY TO DELETE LINE	DEL
KEY TO END FILE	Ctrl C
KEY TO MOVE CURSOR DOWN	down arrow
KEY TO MOVE CURSOR LEFT	left arrow
KEY TO MOVE CURSOR RIGHT	right arrow
KEY TO MOVE CURSOR UP	up arrow



BUILD A USER MASTER  
SYSTEM.MISCINFO INSTALLATION

Terminals: TV912C,TV920C ANSI Standard:  
TV925,TV950: (VT 100 series)

EDITOR ACCEPT KEY	Ctrl C	Ctrl C
EDITOR ESCAPE KEY	ESC ESC	ESC ESC
EDITOR EXCHANGE-DELETE KEY	CHAR DELETE	Ctrl D
EDITOR EXCHANGE-INSERT KEY	CHAR INSERT	Ctrl E
KEY FOR BREAK	Ctrl @	NUL (see note 1)
KEY FOR FLUSH	Ctrl F	Ctrl F
KEY FOR STOP	Ctrl S	Ctrl S
KEY TO ALPHA LOCK	Ctrl R	Ctrl R
KEY TO DELETE CHARACTER	BACKSPACE	BACKSPACE
KEY TO DELETE LINE	DEL	DELETE
KEY TO END FILE	Ctrl C	Ctrl C
KEY TO MOVE CURSOR DOWN	down arrow	down arrow
KEY TO MOVE CURSOR LEFT	left arrow	left arrow
KEY TO MOVE CURSOR RIGHT	right arrow	right arrow
KEY TO MOVE CURSOR UP	up arrow	up arrow

**Note 1:** Determine which key will generate the NUL ASCII value. On the VT102 this is Ctrl space. On some terminals this is Ctrl @. This may be changed with SETUP.

BUILD A USER MASTER  
SYSTEM.MISCINFO INSTALLATION

Terminals:	VT52:	Heath H19 (Note 2)
EDITOR ACCEPT KEY	Ctrl C	Ctrl C
EDITOR ESCAPE KEY	ESC ESC	ESC ESC
EDITOR EXCHANGE-DELETE KEY	Ctrl D	Ctrl D
EDITOR EXCHANGE-INSERT KEY	Ctrl E	Ctrl E
KEY FOR BREAK	Ctrl space	Ctrl @
KEY FOR FLUSH	Ctrl F	Ctrl F
KEY FOR STOP	Ctrl S	Ctrl S
KEY TO ALPHA LOCK	Ctrl R	Ctrl R
KEY TO DELETE CHARACTER	BACKSPACE	BACKSPACE
KEY TO DELETE LINE	DELFTTE	DELETE
KEY TO END FILE	Ctrl C	Ctrl C
KEY TO MOVE CURSOR DOWN	down arrow	down arrow
KEY TO MOVE CURSOR LEFT	left arrow	left arrow
KEY TO MOVE CURSOR RIGHT	right arrow	right arrow
KEY TO MOVE CURSOR UP	up arrow	up arrow

**Note 2:** Consider using the Keypad Shifted option so that the shift key is not necessary when using the arrow keys.

BUILD A USER MASTER  
SYSTEM.MISCINFO INSTALLATION

Terminals:	IQ120:	Hazeltine 1500
EDITOR ACCEPT KEY	Ctrl C	Ctrl C
EDITOR ESCAPE KEY	ESC	ESC
EDITOR EXCHANGE-DELETE KEY	Ctrl D	Ctrl D
EDITOR EXCHANGE--INSERT KEY	Ctrl E	Ctrl E
KEY FOR BREAK	Ctrl underline	Ctrl ^
KEY FOR FLUSH	Ctrl F	Ctrl F
KEY FOR STOP	Ctrl S	Ctrl S
KEY TO ALPHA LOCK	Ctrl R	Ctrl R
KEY TO DELETE CHARACTER	BACKSPACE	BACKSPACE
KEY TO DELETE LINE	DELETE	RUBOUT
KEY TO END FILE	Ctrl C	Ctrl C
KEY TO MOVE CURSOR DOWN	down arrow	down arrow
KEY TO MOVE CURSOR LEFT	left arrow	left arrow
KEY TO MOVE CURSOR RIGHT	right arrow	right arrow
KEY TO MOVE CURSOR UP	up arrow	up arrow

BUILD A USER MASTER  
SYSTEM.MISCINFO INSTALLATION

Terminals:	ADDS	ADM3A
	Regent 25	
EDITOR ACCEPT KEY	Ctrl C	Ctrl C
EDITOR ESCAPE KEY	ESC	ESC
EDITOR EXCHANGE-DELETE KEY	Ctrl D	Ctrl D
EDITOR EXCHANGE-INSERT KEY	Ctrl E	Ctrl E
KEY FOR BREAK	Ctrl ^	Ctrl ^
KEY FOR FLUSH	Ctrl X	Ctrl F
KEY FOR STOP	Ctrl S	Ctrl S
KEY TO ALPHA LOCK	Ctrl R	Ctrl R
KEY TO DELETE CHARACTER	BACKSPACE	BACKSPACE
KEY TO DELETE LINE	RUBOUT	RUBOUT
KEY TO END FILE	Ctrl C	Ctrl C
KEY TO MOVE CURSOR DOWN	down arrow	down arrow
KEY TO MOVE CURSOR LEFT	left arrow	left arrow
KEY TO MOVE CURSOR RIGHT	right arrow	right arrow
KEY TO MOVE CURSOR UP	up arrow	up arrow

BUILD A USER MASTER  
SYSTEM.MISCINFO INSTALLATION

Terminals:	ADDS	Freedom 100
	Viewpoint 60	
EDITOR ACCEPT KEY	Ctrl C	Ctrl C
EDITOR ESCAPE KEY	ESC	ESC
EDITOR EXCHANGE-DELETE KEY	Ctrl D	Ctrl D
EDITOR EXCHANGE-INSERT KEY	Ctrl E	Ctrl E
KEY FOR BREAK	Ctrl ^	Ctrl ]
KEY FOR FLUSH	Ctrl X	Ctrl F
KEY FOR STOP	Ctrl S	Ctrl S
KEY TO ALPHA LOCK	Ctrl R	Ctrl R
KEY TO DELETE CHARACTER	BACKSPACE	BACKSPACE
KEY TO DELETE LINE	RUBOUT	RUBOUT
KEY TO END FILE	Ctrl C	Ctrl C
KEY TO MOVE CURSOR DOWN	down arrow	down arrow
KEY TO MOVE CURSOR LEFT	left arrow	left arrow
KEY TO MOVE CURSOR RIGHT	right arrow	right arrow
KEY TO MOVE CURSOR UP	up arrow	up arrow

BUILD A USER MASTER  
SYSTEM.MISCINFO INSTALLATION

Terminals:	VIS52	VI550
EDITOR ACCEPT KFY	Ctrl C	Ctrl C
EDITOR ESCAPE KEY	ESC ESC	ESC ESC
EDITOR EXCHANGE-DELETE KEY	DELETE char	DELETE char
EDITOR EXCHANGE-INSERT KEY	INSERT char	INSERT char
KEY FOR BREAK	Ctrl @	Ctrl @
KEY FOR FLUSH	Ctrl F	Ctrl F
KEY FOR STOP	Ctrl S	Ctrl S
KEY TO ALPHA LOCK	Ctrl R	Ctrl R
KEY TO DELETE CHARACTER	BACKSPACE	BACKSPACE
KEY TO DELETE LINE	DEL	DEL
KEY TO END FILE	Ctrl C	Ctrl C
KEY TO MOVE CURSOR DOWN	down arrow	down arrow
KEY TO MOVE CURSOR LEFT	left arrow	left arrow
KEY TO MOVE CURSOR RIGHT	right arrow	right arrow
KEY TO MOVE CURSOR UP	up arrow	up arrow

● SETUP.CODE

SETUP.CODE is used to define various parameters of the p-System. Refer to the p-System OPERATING SYSTEM MANUAL for details. An example follows which shows the setup for a TeleVideo 925. (For those that are interested, the actual position of the information in the MISCINFO file is given as a word offset and bits used.)

The following Setup program information is for the TeleVideo 925 terminal. The items marked with a single '\*' are appropriate for any SAGE II/IV computer.

	FIELD FUNCTION	TV925	wrд:bits
	BACKSPACE	BS	34:0-7
*	CODE POOL BASE [FIRST WORD]	1	18:0-15
*	CODE POOL BASE [SECOND WORD]	H3400	19:0-15
*	CODE POOL SIZE	H4DFF	17:0-15
**	EDITOR ACCEPT KEY	ETX="C	45:8-15
**	EDITOR ESCAPE KEY	ESC	44:8-15
	EDITOR EXCHANGE - DELETE KEY	W	24:0-7
	EDITOR EXCHANGE - INSERT KEY	Q	24:8-15
	ERASE LINE	NUL	35:0-7
	ERASE SCREEN	NUL	35:8-15
	ERASE TO END OF LINE	T	32:8-15
	ERASE TO END OF SCREEN	Y	32:0-7
**	FIRST SUBSIDIARY VOL NUMBER	13	13:0-15
*	HAS 8510A	FALSE	29:1
*	HAS BYTE FLIPPED MACHINE	TRUE	29:9
*	HAS CLOCK	TRUE	29:0
*	HAS EXTENDED MEMORY	TRUE	16:0
	HAS LOWER CASE	TRUE	29:2
	HAS RANDOM CURSOR ADDRESSING	TRUE	29:3
	HAS SLOW TERMINAL	FALSE	29:4
note 1	HAS SPOOLING	FALSE	15:0

Note 1 This item should be marked TRUE only if the Printer

BUILD A USER MASTER  
SYSTEM.MISCINFO INSTALLATION

Spooler is desired.



BUILD A USER MASTER  
SYSTEM.MISCINFO INSTALLATION

	FIELD FUNCTION	TV925	wrд:bits
*	HAS WORD ORIENTED MACHINE	FALSE	29:10
**	KEYBOARD INPUT MASK	127	46:0-7
**	KEY FOR BREAK	NUL	42:0-7
**	KEY FOR FLUSH	ACK#^ F	41:8-15
**	KEY FOR STOP	DC3= S	42:8-15
**	KEY TO ALPHA LOCK	DC2= R	46:8-15
**	KEY TO DELETE CHARACTER	BS	43:0-7
**	KEY TO DELETE LINE	DEL	44:0-7
**	KEY TO END FILE	FTX=^C	41:0-7
	KEY TO MOVE CURSOR DOWN	SYN=^V	39:8-15
	KEY TO MOVE CURSOR LEFT	BS	40:0-7
	KEY TO MOVE CURSOR RIGHT	FF =^L	40:8-15
	KEY TO MOVE CURSOR UP	VT =^K	39:0-7
	LEAD IN FROM KEYBOARD	ESC	45:0-7
	LEAD IN TO SCREEN	ESC	31:0-7
**	MAX NUMBER OF SUBSIDIARY VOLs	4	23:8-15
**	MAX NUMBER OF USER SERIAL VOL	0	23:0-7
	MOVE CURSOR HOME	RS = ^^	31:8-15
	MOVE CURSOR RIGHT	FF =^L	33:0-7
	MOVE CURSOR UP	VT =^K	33:8-15
**	NON PRINTING CHARACTER	?	43:8-15
	PREFIXED[DELETE CHARACTER]	FALSE	36:5-5
**	PREFIXED[EDITOR ACCEPT KEY]	FALSE	47:12
note 2	PREFIXED[EDITOR ESCAPE KEY]	TRUE	47:9
	PREFIXED[EDITOR EXCHANGE - DELETE KEY	TRUE	47:15
	PREFIXED[EDITOR EXCHANGE - INSERT KEY	TRUE	47:14
	PREFIXED[ERASE LINE]	FALSE	36:7
	PREFIXED[ERASE SCREEN]	FALSE	36:6
	PREFIXED[ERASE TO END OF LINE	TRUE	36:2
	PREFIXED[ERASE TO END OF SCRN	TRUE	36:3

Note 2 If the LEAD IN FROM KEYBOARD is ESC then the PREFIXED[EDITOR ESCAPE KEY] should be TRUE. This will require that two Escape keys be typed for the EDITOR ESCAPE function.

BUILD A USER MASTER  
 SYSTEM.MISCINFO INSTALLATION

	FIELD FUNCTION	TV925	wrд:bits
	PREFIXED[KEY TO DELETE CHAR	FALSE	47:11
	PREFIXED[KEY TO DELETE LINE]	FALSE	47:10
	PREFIXED[KEY TO MOVE DOWN	FALSE	47:3
	PREFIXED[KEY TO MOVE LEFT	FALSE	47:1
	PREFIXED[KEY TO MOVE RIGHT	FALSE	47:0
	PREFIXED[KEY TO MOVE UP	FALSE	47:2
	PREFIXED[MOVE CURSOR HOME]	FALSE	36:4
	PREFIXED[MOVE CURSOR RIGHT]	FALSE	36:1
	PREFIXED[MOVE CURSOR UP]	FALSE	36:0
**	PREFIXED[NON PRINTING CHAR	FALSE	47:4
**	PRINTABLE CHARACTERS	13,32-126	48:0-7
	SCREEN HEIGHT	24	37:0-15
	SCREEN WIDTH	80	38:0-15
*	SEGMENT ALIGNMENT	0	20:0-15
*	STUDENT	FALSE	29:5
	VERTICAL MOVE DELAY	6	34:8-15

\* indicates proper setting for SAGE II/IV System  
 \*\* indicates suggested assignment (but not required)

#### XIV.04 GOTOXY INSTALLATION :

GOTOXY is a UNIT (a part of a program) that defines the commands to position the cursor on the screen. The screen is usually considered to have 80 characters across and 24 lines down. A point on the screen is found by sending GOTOXY an X value to indicate how far across the screen to move, and a Y value to show how far down to move. Almost all p-System programs need GOTOXY to run properly.

A "vanilla" GOTOXY is shipped on the SYSTEM MASTER disk. Hopefully, this uncomplicated definition will work well enough with your terminal at first to let you build a good SYSTEM.MISCINFO for normal use.

Note that SETUP does not use GOTOXY. Once a SYSTEM.MISCINFO is configured, the vanilla GOTOXY routine attempts to use the defined home and cursor movement commands to simulate the GOTOXY function. In this manner, the screen editor may be used to construct a correct GOTOXY routine for the terminal. This means building a temporary system with the new SYSTEM.MISCINFO but using the vanilla GOTOXY as shipped in SYSTEM.PASCAL on the SYSTEM MASTER.

Choose a file from the list below which matches your terminal. Remember that your terminal may be able to EMULATE one of the terminals below. If your terminal is NOT listed, you may have to write your own GOTOXY.

Terminal:	Install in SYSTEM.PASCAL
QUME QVT102	TV925.GOTO.CODE
TeleVideo 925/950	TV925.GOTO.CODE
TeleVideo 912C/920C	TV925.GOTO.CODE
Heath H19	VT52.GOTO.CODE
SOROC IQ120	TV925.GOTO.CODE
Hazeltine 1500	H1500.GOTO.CODE
ADDS Regent 25	VT52.GOTO.CODE
ADDS Viewpoint 60	VT52.GOTO.CODE
ADM3A	TV925.GOTO.CODE
Freedom 100	TV925.GOTO.CODE

BUILD A USER MASTER  
GOTOXY INSTALLATION

DEC VT52	VT52.GOTO.CODE
VISUAL V550 (emulating VT52 with 33 lines)	VIS52.GOTO.CODE
VISUAL V550	V550.GOTO.CODE
ANSI Standard Term (DEC VT100 series)	ANSIGOTOXY.CODE

NOTE: For ANSI terminals, ANSI.CODE must be installed in SYSTEM.PASCAL to replace the existing SCREENOPS routines.

If your terminal does not match any above, turn to the writeup on WRITING A GOTOXY which is later in this section. Once you have a GOTOXY, it must be loaded into the file SYSTEM.PASCAL with LIBRARY.CODE.

● GOTOXY AND THE LIBRARIAN

LIBRARY.CODE acts like a librarian for p-System programs. Programs are made of UNITS. LIBRARY.CODE can add, remove or delete these UNITS from a program. At this point, you want to use LIBRARIAN to delete the old GOTOXY UNIT and add the new one to SYSTEM.PASCAL. SYSTEM.PASCAL is the operating system program itself. For details on how LIBRARY.CODE works refer to the p-SYSTEM OPERATING SYSTEM MANUAL.

EXAMPLE: If you have a Hazeltine 1500 terminal, you will install the H1500.GOTO.CODE unit in SYSTEM.PASCAL on the SCRATCH: volume that will become your USER MASTER.

THE SCREEN SHOWS:	YOU TYPE:
Command: E(dit,R(un,F(ile..... X	
Execute what file?..... LIBRARY <cr>	
Library: [z12]	
Output file?..... SCRATCH:SYSTEM.PASCAL <cr>	
Input file?..... H1500.GOTO	

The screen will show the single GOTOXY unit in H1500.GOTO.CODE.

Now type "T" ( for toggle) so that the interface section of the units is not copied. Then transfer the GOTOXY unit in slot 0 (zero not "0" ) to slot 21 of the new file:

THE SCREEN SHOWS:	YOU TYPE:
Toggle interface section flag:.. T	
Transfer unit 0 to slot 21..... 0 then 21	

Slot 21 is where the old GOTOXY unit is in the current SYSTEM.PASCAL. The new GOTOXY unit for the H1500 will now replace it.

BUILD A USER MASTER  
GOTOXY INSTALLATION

The screen should look like this:

```
Library: N(ew, 0-9(slot-to slot), E(very, S(lect, C(omp-unit?  
From #?0 To Slot #? 21  
21 u GOTOXY 68  
Output file is 2 blocks long
```

### ANSI TERMINAL

Note that if you have an ANSI terminal you must now install the new ANSI.CODE unit in place of the old SCREENOPS unit. Skip this if you do not have an ANSI terminal.

```
THE SCREEN SHOWS:          YOU TYPE:

Library: N(ew, 0-9(slot-to slot) N
Input file?..... ANSI.CODE
  0 u SCREENOP  590
  1 s SEGSCINI  489
  2 s SEGSCPRO  229
  3 s SEGSCCHE  126
Library: N(ew,0-9(slot-to-slot) 0
From #20 To Slot #?..... 17
Library: N(ew, 0-9(slot-to slot) 1
From #21 To Slot #?..... 18
Library: N(ew, 0-9(slot-to slot) 2
From #22 To Slot #?..... 19
Library: N(ew, 0-9(slot-to slot) 3
From #23 To Slot #?..... 20
```

### OPERATING SYSTEM UNITS

Now transfer every unit from SYSTEM.PASCAL except the old GOTOXY unit (and the old ANSI unit) to the new SYSTEM.PASCAL.

```
Library: N(ew, 0-9(slot-to slot) N
Input file?..... SYSTEM.PASCAL <cr>
Library: N(ew, 0-9(slot-to slot) E
```

# BUILD A USER MASTER GOTOXY INSTALLATION

When finished the screen will show: As each unit is loaded, it will be displayed on the screen:

```
Library: N(ew, 0-9(slot-to slot), E(very, S(lect, C(omp-unit?)
0 u KERNEL      1952
1 u INITOPS     1680
2 u GETCMD      5364
3 u HEAPOPS     285
4 u EXTRAHEA   747
5 u PERMHEAP    192
6 u COMMANDI   986
7 u SMALLCOM    166
8 u SOFTOPS     604
9 u STRINGOP   236
10 u PRNTRERR   715
11 u OSUTIL     244
12 u CONCURRE   174
13 u PASCALIO   928
14 u EXTRAIO   358
15 u USERPROG  1826
16 u FILEOPS    2421
17 u SCREENOP   582
18 u SEGSCINI   508
19 u SEGSPRO    229
20 u SEGSCCHE   126
21 u GOTOXY     64
22 u DEBUGGER   490
23 u EXTRALEX  5983
24 u SPOOLOPS   184
25 u SPOOLTAS   505
26 u REALOPS    2189
```

When finished, you will see just the last units loaded.

```
----
----
20 u SEGSCCHE   126
21 u GOTOXY     64
22 u DEBUGGER   490
23 u EXTRALEX  5983
24 u SPOOLOPS   184
25 u SPOOLTAS   505
26 u REALOPS    2189
```

```
Library: N(ew, 0-9(slot-to slot), E(very, S(lect, C(omp-unit?)
```

Now quit and save the new SYSTEM.PASCAL file.

THE SCREEN SHOWS:	YOU TYPE:
Library: N(ew, 0-9(slot-to slot)	q
Notice?.....	<cr>

The NOTICE is optional.



BUILD A USER MASTER  
GOTOXY INSTALLATION

At this point, SCRATCH: will contain a new operating system, (SYSTEM.PASCAL), which will handle the cursor positioning requirements of the selected (Hazeltine) terminal.

## BUILD A USER MASTER GOTOXY INSTALLATION

### ● GOTOXY PROGRAM

If you are forced to write your own GOTOXY for your terminal, you should start with the sample program shipped on your SYSTEM MASTER diskette. This program is called SAMPLEGOTO.TEXT and is shown on the next page.

Editing the file to add your changes may be interesting since you need the GOTOXY for the editor to work properly and this is what you are trying to build. If you have access to another SAGE or another terminal that is already set up, it is more convenient to use that system to bring up the new one.

When trying to create your own GOTOXY, it is helpful to install a proper SYSTEM.MISCINFO first.

Also, even if the "Vanilla" GOTOXY works for your terminal, you should consider doing a customized version since it will run much faster.

The TELL array is the part of the program that is usually changed. TELL defines the command sequence used to move the cursor. For example, the definition for the TV925 would be:

```
TELL[0] := 27;           {Value of ESC}
TELL[1] := ORD('=');    {Value of the equal sign}
TELL[TELL_LENGTH_MINUS_1 - 1] := Y + OFFSET;
TELL[TELL_LENGTH_MINUS_1] := X + OFFSET;
```

BUILD A USER MASTER  
GOTOXY INSTALLATION

For the Hazeltine 1500 the command is different and the X and Y positions are reversed:

```
TELLC0] := 27;           {Value of ESC}
TELLC1] := 17;           {Value of CTRL/Q}
TELLTELL_LENGTH_MINUS_1 - 1] := X + OFFSET;
TELLTELL_LENGTH_MINUS_1] := Y + OFFSET;
```

If the command sequence is longer than 4 characters, the value of TELL\_LENGTH\_MINUS\_1 must be changed. (SAMPLEGOTO has it set to 3.)

SAMPLEGOTO shows a very common way of calculating the movement. If, for example, X (the desired position across was 10), then the column character would be the 10th printable ASCII "). Since the first 32 characters are non-printable characters, the value of the character is calculated by adding 32 to X. Thus 32 is the OFFSET. Your terminal may have a different offset or may use another method of calculation entirely.

Once you have edited the program as desired, COMPILE it and load the result into SYSTEM.PASCAL following the steps described on page 135.

Following is a listing of the sample GOTOXY routine contained in the file SAMPLEGOTO.TEXT.

## BUILD A USER MASTER GOTOXY INSTALLATION

```
{ $U- } { ALWAYS include this compiler directive. }
UNIT GOTOXY;
INTERFACE
  PROCEDURE AGOTOXY(X,Y: INTEGER);
IMPLEMENTATION
  USES {$U SCREENOPS.CODE} SCREENOPS (SC_TX_PORT, SC_PORT);
  PROCEDURE AGOTOXY;

  CONST TELL_LENGTH_MINUS_1 = 3;
         OFFSET = 32;
  { You may have to change these, depending on your terminal. }

  VAR   TELL: PACKED ARRAY [0..TELL_LENGTH_MINUS_1]
         OF 0..255;
  BEGIN
    IF X>79 THEN X:=79
    ELSE IF X<0 THEN X:=0;
    IF Y>23 THEN Y:=23
    ELSE IF Y<0 THEN Y:=0;
    { This range-checking is necessary. The actual
      screenwidth and height may be different for you. }

    WITH SC_PORT DO
      BEGIN
        CUR_X:=X-COL;
        CUR_Y:=Y-ROW;
      END;

    { These first elements of TELL must contain
      the characters which tell your terminal to
      position the cursor at (X,Y):
      fill in the blanks... }
    TELL[0] := 0 {change this};
    TELL[1] := 0 {and this};
    { The actual X and Y values are usually the
      last things in the array;
      the order may be different on your terminal. }
    TELL[TELL_LENGTH_MINUS_1 - 1] := Y + OFFSET;
    TELL[TELL_LENGTH_MINUS_1] := X + OFFSET;

    UNITWRITE(1,TELL,TELL_LENGTH_MINUS_1 + 1)
  END {AGOTOXY};
END {UNIT GOTOXY}.
```

#### XIV.05 USER MASTER FILES :

The special installation for the terminal is now done. You are ready to transfer the rest of the system files needed to the SCRATCH: volume. The following files are the only ones commonly transferred. A short description of each file is given in the technical manual. If you have followed the steps given in the sections before this, then your SYSTEM.MISCINFO and SYSTEM.PASCAL should already be on the new volume.

MAIN:

SYSTEM.PASCAL	125	20-Dec-82	(already there)
SYSTEM.MISCINFO	1	17-Mar-83	(already there)
SYSTEM.LIBRARY	7	13-Sep-82	
SYSTEM.SYNTAX	14	18-May-82	
SYSTEM.FILER	39	27-Aug-82	
SYSTEM.EDITOR	50	14-Oct-82	
SYSTEM.COMPILER	107	16-Aug-82	
SETUP.CODE	36	7-Jun-82	
SAGE4UTIL.CODE	67	5-Aug-83	
LIBRARY.CODE	13	10-Dec-82	
SAGEDATE.CODE	32	5-Aug-83	
ENDBOOT	1	13-Sep-82	
SYSTEM.BIOS	33	8-Aug-83	
SYSTEM.INTERP	23	8-Jun-83	

Note that SYSTEM.PASCAL and SYSTEM.MISCINFO are the first files on the diskette. This is not really necessary BUT it does make booting faster. Another reason for putting SYSTEM.PASCAL first is so that it does not get moved when a "Krunch" is done. ( See Filer options.) If SYSTEM.PASCAL is moved (in the "ROOT" volume which is the one you booted from) then the system will not be able to find all of its units (or segments) and it will stop.

BUILD A USER MASTER  
USER MASTER FILES

Once you have loaded all of the files needed, the SCRATCH: volume is complete. At this point the final steps differ for SAGE IV users and SAGE II users:

If you have a SAGE II (or a SAGE IV with two floppies):

```
THE SCREEN SHOWS:          YOU TYPE:

Command: E(dit,R(un,F(file..... F
Filer..... F (memory lock)
Filer..... C
Change what file?..... #5:,USER:
```

If you have a SAGE IV with ONE floppy and built your area on the SCRATCH: hard disk partition, then you should transfer it to a diskette:

```
THE SCREEN SHOWS:          YOU TYPE:

Command: E(dit,R(un,F(file..... F
Filer..... F (memory lock)
```

REMOVE THE DISK IN DRIVE #4:  
INSERT A BLANK FORMATTED DISKETTE

```
Filer..... T
Transfer from..... SCRATCH:,#4:
Filer..... C
Change what file?..... #4:,USER:
```

USER MASTER diskette is complete. It should now be checked to see if the terminal works correctly.

#### XIV.06 USER MASTER CHECKOUT :

If the USER MASTER installation (see previous "how to " sections) has been done properly you should be able to boot and run the diskette. Put the diskette in floppy drive #4:, (Switch 5 and 6 of Group A are down) and reset the system. The startup message should appear, then type "IF" to boot to the p-System command line.

Now run the editor (type E from the command line) and try all of the operations.

If everything is satisfactory, make a copy of your master diskette (See the GETTING STARTED section) and save your original as an archive master.

If you have a hard disk system, you will want to load the single user partition with the new configuration. If the volume already has system files on it you will only need to transfer over the two new files: SYSTEM.MISCINFO and SYSTEM.PASCAL .

THE SCREEN SHOWS:	YOU TYPE:
Command: E(edit,R(run,F(file.....	F
File.....	R
Remove what file?.....	SYS:SYSTEM.PASCAL
File.....	R
Remove what file?.....	SYS:SYSTEM.MISCINFO
File.....	T
Transfer from.....	#4:SYSTEM.PASCAL,SYS:\$
File.....	T
Transfer from.....	#4:SYSTEM.MISCINFO,SYS:\$

Check to see that the partition boots properly by setting switch 6 of group A back up and reset. Try the editor and various commands until you are satisfied that everything is working.

## PRINTER INSTALLATION

### XV PRINTER INSTALLATION :

Almost any printer with a serial or parallel interface can be connected to the SAGE. The SAGE II/IV parallel printer port "PRINTER" is usually used for the system printer. Most Centronics-like printers will run on this port with few software changes. Also the "MODEM" port and AUX ports can be used for printers with a serial interface.

The computer must be told which port has the printer. This is done using SAGE4UTIL (or in Multi-user, MU.UTIL.) Execute SAGE4UTIL and select the printer option. It will then ask to to select one of six port options:

Remote serial channel	(MODEM)
Parallel port	(PRINTER)
Extra serial channel #1	(AUX 1)
Extra serial channel #2	(AUX 2)
Extra serial channel #3	(AUX 3)
Extra serial channel #4	(AUX 4)

Select the one you are going to use. Next, verify that your printer needs a Linefeed sent after every carriage return. Some printers, like the RADIO SHACK DAISY WHEEL, do this function themselves. Most do not so the option is normally ON.

If you have selected one of the serial channels (ports), you must then configure that port to match your printer communications protocol. Type <cr> to return to the main menu of SAGE4UTIL and select the correct channel. Then set the BAUD RATE, number of bits, etc. If you are not sure what you should use here we suggest:

- Data Set Ready check before transmitting ON.
- Computer baud rate to match printer baud rate = 9600.
- 7 data bits
- 1 stop bit



Refer to your printer manual to find out how to set the printer switches. Remember that the computer setting and the printer setting **MUST** match. Note that if you have more than one type of printer that will share the same port, it is a good idea to set up all printers the same way if possible.

To set up a printer on the parallel port, select that option from the SAGE4UTIL menu. You must then specify how the parallel port is accessed, with Interrupts on or in a Polling loop. If your printer manual indicates that it uses the BUSY signal to tell the computer when the next data is available then chose the Polling mode. Otherwise turn the Interrupt mode on. ( The polling delay is only used in the Polling mode and rarely needs changing.)

To set up a printer in MULTI-USER mode, the program MU.UTIL is used instead of SAGE4UTIL. It works in much the same way. (Refer to the SAGE II/IV TECHNICAL MANUAL.) One important difference is that the REMOTE CHANNEL FLAG must be set ON if the printer is connected to a serial port. Access control for the port is usually set so that all users can write to the port. (Write allowed ON.) The Exclusive control flags must also be set On to prevent user printouts from becoming intermixed. It is also most common to set the "Hang and Wait" flags for all users ON with a timeout threshold of several seconds. Refer to the Multi-User section of the SAGE II/IV TECHNICAL MANUAL.

### **XV.01 PRINTER TYPES :**

The following pages identify printers known to work on the SAGE II/IV and details of their configuration and cable needs.

PRINTER INSTALLATION  
PRINTER TYPES

● TI OMNI 810

The TI OMNI 810 is connected to the second serial port, "MODEM". Use SAGE4UTIL (Multi-user, MU.UTIL) to configure the printer option to the REMOTE channel. Then configure the remote channel for:

Data Set Ready check before transmitting ON.  
Computer baud rate to match printer baud rate.  
7 data bits  
1 stop bit

SAGE cable part numbers are:

CC0003B	10ft	5-cond wire
CC0004B	25ft	5-cond wire
CC0071A	100ft	5-cond wire

The cable is wired:

SAGE	WIRE COLOR	PRINTER
1	-----BROWN-----	> 1
2	-----BLACK-----	> 3
3	-----RED-----	> 2
5	-->9	
		6-->8-->9
6	-----WHITE-----	> 11
7	-----GREEN-----	> 7

Dummy pins are inserted in 13, 14, 25 as these positions are unused. The sage part # is marked on both ends of the cable. SAGE MODEM is marked on the SAGE II/IV end. The printer model is marked on the printer end.

● SIEMENS INKJET PRINTER

The SIEMENS INKJET printer is connected to the second serial port, "MODEM". Use SAGE4UTIL (Multi-user, MU.UTIL) to configure the printer option to the REMOTE channel. Then configure the remote channel for:

Data Set Ready check before transmitting ON.  
Computer baud rate to match printer baud rate.  
7 data bits  
1 stop bit

SAGE cable part numbers are:

CC0062B	10ft	5-cond wire
CC0063A	25ft	5-cond wire
CC0064A	100ft	5-cond wire

The cable is wired:

SAGE	WIRE COLOR	PRINTER
1	-----BROWN-----	> 1
2	-----BLACK-----	> 3
3	-----RED-----	> 2
5	-->9	
6	-----WHITE-----	> 25
7	-----GREEN-----	> 7

Dummy pins are inserted in 13, 14, 25 as these positions are unused. The SAGE part # is marked on both ends of the cable. SAGE MODEM is marked on the SAGE II/IV end. The printer model is marked on the printer end.

Note: Max length of cable is 10 ft. at 9600 baud.

PRINTER INSTALLATION  
PRINTER TYPES

● SIEMENS INKJET PRINTER (AUX PORT)

The SIEMENS INKJET printer can also be connected to one of the AUXILIARY serial ports. Use SAGE4UTIL (Multi-user, MU.UTIL) to configure the printer option to the AUX channel. Then configure that channel for:

Computer baud rate to match printer baud rate.  
7 data bits  
1 stop bit

SAGE cable part numbers are:

CC0068B	10ft	5-cond wire
CC0069A	25ft	5-cond wire
CC0070A	100ft	5-cond wire

The cable is wired:

SAGE	WIRE COLOR	PRINTER
1	-----BROWN----->	1
2	-----BLACK----->	2
3	-----RED----->	3
4	-----WHITE----->	25
7	-----GREEN----->	7

Dummy pins are inserted in 13, 14, 25 as these positions are unused. The SAGE part # is marked on both ends of the cable. SAGE MODEM is marked on the SAGE II/IV end. The printer model is marked on the printer end.

Note: Max cable length for 9600 baud operation is 10 ft.

● DEC LA50 PRINTER

The DEC LA50 printer is connected to the second serial port "MODEM". Use SAGE4UTIL (Multi-user, MU.UTIL) to configure the printer option to the REMOTE channel. Then configure the remote channel for:

Data Set Ready check before transmitting ON.  
Computer baud rate to match printer baud rate.  
7 data bits  
1 stop bit

SAGE cable part numbers are:

CC0065A	10ft	5-cond wire
CC0066A	25ft	5-cond wire
CC0067A	100ft	5-cond wire

The cable is wired:

SAGE	WIRE COLOR	PRINTER
1	-----BROWN-----	> 1
2	-----BLACK-----	> 3
3	-----RED-----	> 2
5	-->9	
6	-----WHITE-----	> 20
7	-----GREEN-----	> 7

Dummy pins are inserted in 13, 14, 25 as these positions are unused. The sage part # is marked on both ends of the cable. SAGE MODEM is marked on the SAGE II/IV end. The printer model is marked on the printer end.

PRINTER INSTALLATION  
PRINTER TYPES

● QUME SPRINT 9/45

The QUME SPRINT 9/45 printer is connected to the second serial port "MODEM". Use SAGE4UTIL (Multi-user, MU.UTIL) to configure the printer option to the REMOTE channel. Then configure the remote channel for:

Data Set Ready check before transmitting ON.  
Computer baud rate to match printer baud rate.  
7 data bits  
1 stop bit

SAGE cable part numbers are:

CC0034A	10ft	5-cond wire
CC0035A	25ft	5-cond wire
CC0076A	100ft	5-cond wire

The cable is wired:

SAGE	WIRE COLOR	PRINTER
1	-----BROWN-----	> 1
2	-----BLACK-----	> 3
3	-----RED-----	> 2
5	-->9	
6	-----WHITE-----	> 20
7	-----GREEN-----	> 7

Dummy pins are inserted in 13, 14, 25 as these positions are unused. The sage part # is marked on both ends of the cable. SAGE MODEM is marked on the SAGE II/IV end. The printer model is marked on the printer end.

● DIABLO #630 PRINTER

The DIABLO #630 printer is connected to the to the second serial port "MODEM". Use SAGEUTIL (Multi-user, MU.UTIL) to configure the printer option to the REMOTE channel. Then configure the remote channel for:

Data Set Ready check before transmitting ON.  
Computer baud rate to match printer baud rate.  
7 data bits  
1 stop bit

SAGE cable part numbers are:

CC0072A	10ft	5-cond wire
CC0073A	25ft	5-cond wire
CC0074A	100ft	5-cond wire

The cable is wired:

SAGE	WIRE COLOR	PRINTER
2	-----BLACK-----	> 3
3	-----RED-----	> 2
4	-----BROWN-----	> 5-->6-->8
5	-->9	
6	-----WHITE-----	> 11
7	-----GREEN-----	> 7

Dummy pins are inserted in 13, 14, 25 as these positions are unused. The sage part # is marked on both ends of the cable. SAGE MODEM is marked on the SAGE II/IV end. The printer model is marked on the printer end.

PRINTER INSTALLATION  
PRINTER TYPES

● NEC 3510 SPINWRITER

The NEC 3510 printer is connected to the to the second serial port "MODEM". Use SAGE4UTIL (Multi-user, MU.UTIL) to configure the printer option to the REMOTE channel. Then configure the remote channel for:

Data Set Ready check before transmitting ON.  
Computer baud rate to match printer baud rate.  
7 data bits  
1 stop bit

SAGE cable part numbers are:

NONE

This cable configuration was contributed by a user. SAGE has no direct experience with this printer.

The cable is wired:

SAGE	WIRE COLOR	PRINTER
2	-----BLACK----->	3
3	-----RED----->	2
4	-----BROWN----->	4
5	----->	5
5	--->9	
6	-----WHITE----->	19
7	-----GREEN----->	7
8	----->	8
9	----->	9
15	----->	15
16	----->	16
17	----->	17
20	----->	20



● **MICROLINE SERIES**

The MICROLINE series of printers uses the standard parallel printer cable shown on the next page. Use SAGE4UTIL (Multi-user, MU.UTIL) to configure the printer for the parallel port with interrupts.

● **QUME SPRINT 11**

The QUME SPRINT 11 uses the standard parallel printer cable shown on the next page. Use SAGE4UTIL (Multi-user, MU.UTIL) to configure the printer for the parallel port with interrupts.

● **NEC SPINWRITER 5530 PRINTER**

The NEC SPINWRITER 5530 uses the standard parallel printer cable shown on the next page. Use SAGE4UTIL (Multi-user, MU.UTIL) to configure the printer for the parallel port with interrupts.

● **RADIO SHACK DAISY WHEEL PRINTER**

The RADIO SHACK DAISY WHEEL uses the standard parallel printer cable shown on the next page. Use SAGE4UTIL (Multi-user, MU.UTIL) to configure the printer for the parallel port with scheduled polling and with Linefeed after carriage return inhibited.

PRINTER INSTALLATION  
PRINTER TYPES

● PARALLEL PRINTER CABLE

This is the standard cable used for all parallel printer connections. Use SAGE4UTIL (Multi-user, MU.UTIL) to configure the printer option for "Printer on parallel port with interrupts"

CC0006A	6ft		499116-8	Ribbon cable, AMP.
CC0025A	10ft		499571-9	34-pin ribbon cable conn, AMP.
CC0026A	25ft		552931-1	36-pin printer conn., AMP.

The parallel printer cable consists of 3 components. A 34 pin female header connector, A 36 Pin Centronics printer connector and the appropriate length of 34 conductor ribbon cable.

The 34 pin female header connector is placed on the cable such that the pin 1 identifier on the connector is on the same side as the pin 1 identifier on the ribbon cable. Also the connector is placed such that the polarizing tabs on the connector will be facing the ribbon cable.

The 36 pin centronics connector is placed on the cable such that pin 1 of the connector is on the same side as, and all the way towards, the pin 1 identifier of the ribbon cable. This means that pins 35 & 36 of the connector will be left blank.

If the cable is laid on the table such that pin 1 is to the right, the connector should be installed such that its main body is up.

**XV.02 PRINTER PARALLEL PORT :**

The parallel port is designed for interface to a printer. It can also be used as a general purpose 14- bit software output or control port. The connector on the back panel is labeled PRINTER. Pin-outs for the signals :

J8 -1	STROBE'	-clocks the data from computer to printer on the high to low transition.
3	DATA0	-Bit 0 (lsb) of output data byte.
5	DATA1	-Bit 1 of output data byte.
7	DATA2	-Bit 2 of output data byte.
9	DATA3	-Bit 3 of output data byte.
11	DATA4	-Bit 4 of output data byte.
13	DATA5	-Bit 5 of output data byte.
15	DATA6	-Bit 6 of output data byte.
17	DATA7	-Bit 7 (msb) of output data byte.
19	ACK'	-acknowledgement from printer to computer that data byte was received.
21	BUSY	-High indicates that printer is busy.
23	PAPER EMPTY	-High indicates that printer is out of paper.
25	SELECT	-High indicates that device was selected.
26	PRIME'	-Computer sends to printer a low to clear buffer and reset printer logic.
27	.....	-Strap S05 allows connection to +5V or GND. [A] is +5V, [B] is Ground.
28	FAULT'	-Low indicates a printer fault: paper empty, deselect, etc.
2,4,6,8 10,12,14 16,18,20 22,24 31,33	GROUND	-common signal ground is every other pin to minimize noise on signals.
29,30,32	NC	-These pins are not connected.
34		

PRINTER INSTALLATION  
PRINTER SPOOLING

**XV.03 PRINTER SPOOLING :**

The Print Spooler is a program that allows the user to queue and print files concurrently with the execution of the p-System. The Print Spooling is documented in the p-System OPERATING SYSTEM MANUAL. In order to enable the Print Spooling function the option 'HAS SPOOLING' must be set to TRUE in the SYSTEM.MISCINFO file with the program SETUP. In order to take affect, the system must be rebooted. Note that the Spooling option occupies some permanently resident memory and should only be specified if it is definitely going to be used.

**XV.04 PRINTER NOTES :**

The printer configuration can be read and set via program control using the BIOS calls to channel 6 in 68000 assembly code and the CONFIGSAGE unit in PASCAL. Refer to the SAGE II/IV TECHNICAL MANUAL for details.

**XVI SAGE4UTIL :**

SAGE4UTIL is the utility program provided by SAGE which allows the user to redefine system parameters for the various devices: terminal, printer, disks, etc. Most of the parameters will rarely need to be changed. Changing the floppy format to read other diskettes is one of the most frequent uses. Changing the serial port characteristics to add new terminals or devices is also common.

SAGE4UTIL is used mainly on single user systems. MU.UTIL replaces it for most functions on multi-user systems. Both programs are very similar in format and the selections allowed the user.

A different version of SAGE4UTIL may exist for your operating system:

SAGE4UTIL for the SAGE II/IV p-System, described here.  
SAGE4UTL.C for the SAGE II/IV CP/M-68K, see SAGE CP/M notes.

SAGE4UTIL has these major options:

- A- On-Line Configuration
- B- BIOS File Configuration
- C- Floppy Formatter
- D- Bootstrap Copy.
- E- Prepare Drives for Shipping.

SAGE4UTIL allows most options to be changed "on-line". For example, you can change the baud rate of your printer without rebooting. If SAGE4UTIL is being used in a Multi-user system then some options are restricted. Options that are restricted in the MU system have a note in their descriptions in this section.

SAGE4UTIL allows the SYSTEM.BIOS file on any volume to be changed. In this way, a new system can be built under a

SAGE4UTIL

working system.

Parameters which are not frequently changed and are of a very specific nature (such as the setup of the Winchester hard disk) are accessed by the The Low Level Configuration menu.

## XVI.01 MENU OPERATION :

Each menu in SAGE4UTIL has the general form:

```
c  item  val  
c  item  val  
.....
```

Select menu item <CR exits, ! aborts>

Normally the character ( c ) to the left of the desired menu item is typed to select the item.

A carriage return will exit to the previous parent menu.

An exclamation character (!) will exit a number of levels back to a logical point in the menu tree without making any permanent changes.

A menu item may have a value associated with the item. If present, the value is displayed to the right of the item field. Note that the initial menu that appears in SAGE4UTIL does not have any value fields displayed. Menu items without value fields will either call another "subsidiary" menu or are used to drive other functions of the program.

The On-Line Configuration selection in SAGE4UTIL immediately goes to a subsidiary menu allowing configuration selection for a variety of devices. The BIOS File Configuration selection goes to the same menu after stopping to query the user for the name of the BIOS file to be configured. The Floppy Formatter, Bootstrap Copy, and Prepare Drives for Shipping selections drive routines in SAGE4UTIL to perform the specified functions.

## SAGE4UTIL MENU OPERATION

### **NUMERIC fields**

If a numeric (decimal or hex) value is displayed, selecting the item will display the item field on the prompt line and wait for the user to enter a new value. Typing just a carriage return indicates that the item should not be changed and the selection prompt will be re-displayed.

### **BOOLEAN fields**

If a boolean value (On or Off) is displayed, selecting the item will display the item field on the prompt line and wait for the user to enter either "ON" or "OFF". Typing just a carriage return indicates that the item should not be changed and the selection prompt will be re-displayed.

### **TEXT fields**

Some value fields are text strings which are selected on a mutually exclusive basis in a subsidiary menu. Under the Terminal Configuration Control menu, the Terminal Baud Rate, Terminal Parity, Terminal Stop Bits, and Terminal Data Bits fields are of this category. In the subsidiary menu, an asterisk appears to the right of the current selection. If another item is selected, the asterisk moves to indicate the new item. When a carriage return is typed to return to the previous menu, the new selection is displayed.

### **PRINTOUT OPTION**

A built-in printout option lets the user save the configuration in a file or print it out. Typing an '=' at any main prompt will ask for the file name. Typing a '/' at any main prompt will send the contents of the screen to the output file. Menus without data can also be stored allowing the user to build a record of a complete configuration session. The output file is closed on exit from SAGE4UTIL or when another '=' is typed.



## XVI.02 RUNNING SAGE4UTIL :

This section defines how to access the various menus and options available to the user. The previous descriptions of the menu operation give general guidelines for entering and leaving menus. Briefly, all options are generally available by typing a single key. Use carriage returns to exit the menus.

When executed, SAGE4UTIL displays

```
SAGE4UTIL Version xx
Initializing.....

      SAGE4UTIL

A - On-line Configuration
B - BIOS file Configuration
C - Floppy Formatter
D - Bootstrap Copy
E - Prepare Drives for Shipping

Select Menu item <CR exits, ! aborts>:
```

To select a Menu item, type the Character in front of the option. For example, type "A" to select "On-line Configuration".

Each one of the selections will be described in the sections that follow.

Only certain functions can be changed under "A" when SAGE4UTIL is run under the Multi-User environment.

SAGE4UTIL  
RUNNING SAGE4UTIL

### **A... On-line Configuration**

Changes made "on-line" are effective only until the next boot or system reset. This option should be used for temporary changes that only affect the current computing session. When typed, the option will call the configuration menu. **After** the configuration has been set up, the system will ask:

Make On-Line Changes?

Type "Y" to accept the changes or "N" to forget the changes.

Changes made to memory involving the terminal configuration are questioned by the utility before installing. This is because the changes are applied immediately and may garble the following terminal output until the corresponding changes are made in the terminal.

## B... BIOS file Configuration

To make permanent changes, use option "B" to change the BIOS file Configuration. This option will ask:

BIOS file name?

The user should specify the device and file name of the BIOS file to be modified (or examined), typically SYSTEM.BIOS. The device driver configuration parameters are located in the block 1 of the BIOS file. This data is read in for examination and/or modification by the configuration manager. The utility will report:

BIOS Version x.x header read successfully  
Size including buffers: xxxxx bytes.

Type <space> to continue

Then the configuration menu will display. At the end of the session (use carriage returns to exit the menus), SAGE4UTIL will ask:

Ready to write changes to your file?

Type "Y" or "N" . The screen will display:

BIOS changes saved, Type space to continue.

or

BIOS changes abandoned, Type space to continue.

BIOS changes made to a file will **not** take affect until the system is re-booted using the modified BIOS.

SAGE4UTIL  
RUNNING SAGE4UTIL

### C... Floppy Formatter

The format function is necessary to initialize diskettes with address information so that the hardware floppy controller can determine where to read and write the user's data. **Caution : formatting a diskette will destroy any previous data recorded on the diskette.** The diskettes will be formatted according to the parameters set up in the configuration. The screen will display:

```
Floppy disk formatter  
Drive to be formatted - L(left or R(right)?
```

Insert the diskette to be formatted into the drive and type in L or R. The screen will display:

```
Is diskette ready for formatting in Right or Left drive?
```

The user should make sure that the wrong drive (typically containing the system diskette) has not been selected, and that the diskette to be formatted has been placed in the drive before answering "Y".

The utility will reply "Formatting" and print a dot for each track as it is formatted. The 96 TPI diskettes will print four lines of 40 dots. The 48 TPI diskettes, for 40 track drives only, will print two lines of 40 dots (each cylinder has two tracks, one on each side of the diskette).

After the formatting information has been written the utility displays "Verification" and reads back all the tracks, again printing a dot for each track.

```
Formatting  
.....  
.....  
.....  
.....  
Verification  
.....  
.....  
.....
```

After successfully formatting a diskette, the utility will display:

```
Format Complete
More diskettes to format?
```

Type "Y" to repeat the format for another diskette or type "N" to quit.

Problems that may occur while formatting are usually problems with the floppy diskette themselves.

- You cannot format a diskette that is "Write protected". Check to see if a small tab (like a label) is stuck over a notch in the diskette. This generally (but not always) means that the disk is write protected. Remove the label if you are sure that you want to destroy any information that is on the diskette.
- The diskette itself is damaged. Check for obvious scratches, dirt or other indications that the diskette is no good. Sometimes even brand new diskettes will not format.
- If none of the diskettes you have will format, you may have bought the wrong kind. Check to see if there is a 96/100 TPI or 100/96 TPI note on the label.
- Another common problem is that you have not seated the diskette properly in the drive. The latch should make a clear crisp sound as it closes. If not, open the drive and reseal the diskette.

SAGE4UTIL  
RUNNING SAGE4UTIL

### D... Bootstrap Copy

The bootstrap program resides on blocks 0 and 1 of a device. This option allows a bootstrap to be copied from one device to another or from a file to a device. The routine insures that the data is a good SAGE bootstrap by checking the first four characters of the information for the characters "BOOT" or "MUBT".

Remember that the boot on the hard disk is not the same as the boot for the floppy disk. The master release diskette includes the file SAGE.WBOOT.CODE which is the Winchester bootstrap.

The Bootstrap Copy Utility will ask:

Source file or device <just CR quits>?

Once a file or device number ( examples: SAGE.PBOOT.CODE, #4, #4:) is specified the utility asks:

Ready to store bootstrap from file xxxxxxxx  
or volume x

If the reply is "Y" the utility will ask:

Destination file or device <just CR quits>?

Note that a transfer of a bootstrap TO a file is not currently supported.

Once the destination device number is specified the utility asks:

Ready to copy bootstrap on volume x?

If the reply is "Y" the utility will perform the transfer:

Bootstrap data written successfully

Type <space> to continue

The main menu will display.

SAGE4UTIL

- A - On-line Configuration
- B - BIOS file Configuration
- C - Floppy Formatter
- D - Bootstrap Copy
- E - Prepare Drives for Shipping

Select Menu item <CR exits, ! aborts>:

Type a <cr> (carriage return) at this point to return to the p-System menu.

SAGE4UTIL  
RUNNING SAGE4UTIL

### **E... Prepare Drives for Shipping**

The option can be done on a SAGE IV from either Multi-user mode or single user mode.

To ship the system, the Winchester drive heads are moved to a track beyond the normal range of the data. This "shipping track" is specified in the Winchester Information (see the menu in that section). This protects the data surface during shipping. Once the heads are positioned, no further accesses to the drives should be made. Power down the system when the messages below are displayed.

```
Drive x positioned for shipping  
Drive y positioned for shipping  
....  
....  
Ready to power system down.
```

At this point you can turn the power to the system off. The drives should be prepared for shipping anytime that the system is moved.

In case this item is entered accidentally, you can type a <space> to return to the main menu.



### XVI.03 CONFIGURATION CONTROL :

The configuration control manager is called from either the On-line option or the BIOS file change option. The menu offers several selections:

On-Line Configuration Control

- A - Terminal
- B - Remote channel
- C - Left Floppy
- D - Right Floppy
- E - RAM Disk
- F - Printer
- G - Extra Serial Port #1
- H - Extra Serial Port #2
- I - Extra Serial Port #3
- J - Extra Serial Port #4
- K - Parallel port
- L - Time Adjustment
- M - Low Level Configuration

Select Menu item <CR exits, ! aborts>:

Selecting one of the options on this menu will take you to another menu which will allow you to configure the various parameters for that device. If you do not see the selection you want, try "M" the Low level Configuration.

Selections "A", "B", "C", "D", and "G"- "K" can be accessed under the Multi-User environment.

SAGE4UTIL  
CONFIGURATION CONTROL

● A - Terminal configuration

The various options for the Terminal configuration are:

Terminal Configuration Control

Terminal Baud Rate	DIP Switch
Terminal Parity	DIP Switch
Terminal Stop Bits	1 Stop Bit
Terminal Data bits	8 Data Bits
Xon/Xoff on input	On
BREAK to debugger	Off

Select Menu item <CR exits, ! aborts>:

The DIP switch references the GROUP A switches on the back of the computer. Refer to the TERMINAL INSTALLATION section of this manual. Each of the options will present a menu of selections. A star ( \* ) after an option indicates the current selection.

**Baud Rate**

Baud Rate Selection

A - 19200 baud  
B - 9600 baud  
C - 4800 baud  
D - 2400 baud  
E - 2000 baud  
F - 1800 baud  
G - 1200 baud  
H - 600 baud  
I - 300 baud  
J - 200 baud  
K - 150 baud  
L - 110 baud  
M - 75 baud  
N - 50 baud  
O - DIP Switch\*

Menu item <CR exits, ! aborts>:

## Parity

### Parity Selection

- A - Even parity
- B - Odd parity
- C - Disabled parity
- D - DIP Switch\*

Select Menu item <CR exits, ! aborts>:

Note that the DIP switch selection (option D) is for display only and cannot be selected here. It is automatically used when the DIP switch option is selected under the Baud Rate menu.

## Stop bit

### Stop Bit Selection

- A - 1 Stop Bit\*
- B - 1.5 Stop Bits
- C - 2 Stop Bits

Select Menu item <CR exits, ! aborts>:

## Data bits

### Data Bit Selection

- 5 Data Bits
- 6 Data Bits
- 7 Data Bits
- 8 Data Bits\*

Select Menu item <CR exits, ! aborts>:

## XON/XOFF

The 'E' option will set the XON/XOFF handling mode for the terminal. If the XON/XOFF mode is enabled, the terminal driver will respond to XON and XOFF characters generated by

SAGE4UTIL  
CONFIGURATION CONTROL

the terminal to slow down the data going to the terminal. When using this option, the p-System Start/Stop character must be set to XOFF (ASCII DC3, Ctrl/S) using the program SETUP. Manual control of the terminal output will also require typing Ctrl/S (XOFF) to stop the output and Ctrl/Q (XON) to restart the output.

**BREAK KEY**

The actual BREAK KEY on normal terminals generates a continuous signal which causes the receiving USART to detect framing errors. The normal option for the BIOS is to ignore framing errors. If a large number of continuous framing errors (>255) is detected the USART receive channel is turned off and checked only at one second intervals. This allows the terminal to be turned off (often causing continuous framing errors) without turning off the SAGE II/IV computer. The computer can continue to execute a program without being continuously interrupted by the powered down terminal.

The optional mode for the BREAK key (or framing errors) is to enter the PROM Debugger. This mode should only be selected when troubleshooting programs at a low level. All normal program information is preserved and the program may be resumed by typing 'GO' to the Debugger. Refer to the SDT manual.

● B - Remote channel

The Remote Channel is configured much the same way as the Terminal.

Remote Serial Channel Control

A - Remote Serial Baud Rate	9600 baud
B - Remote Serial Parity	Even parity
C - Remote Serial Stop Bits	1 Stop Bit
D - Remote Serial Data bits	7 Data Bits
E - Xon/Xoff for input	Off
F - Xon/Xoff for output	Off
G - DSR Polling	On
H - DSR Polling interval	16384

Select Menu item <CR exits, ! aborts>:

The Baud Rate, Parity, Stop Bit and Data Bit menus for the Remote channel are nearly identical to that of the terminal except for the DSR options and that there are no DIP switch selections for the Remote Channel.

**REMOTE PORT XON-XOFF**

The XON/XOFF protocol is a method used to keep the receiving system from losing data if the incoming data cannot be processed fast enough and the input buffer fills up. A typical case would be where data is being transferred over the remote serial link to be stored on a diskette. The buffer could fill up and overflow while the program is writing the previously received data to diskette.

Using XON/XOFF protocol, the receiving system will send an XOFF character (13H) when the receive buffer is nearly full (240 out of 255 characters). This leaves some room for the transmitting end to respond to the XOFF by stopping transmission. The receiving program will then process characters in the input buffer. When the amount of room available is 1/2 of the buffer (128 characters) the XON character (11H) is sent to turn the transmitting driver back on. This protocol can only be used where the XON and XOFF characters are unique and are never contained in the data. Thus this method will not work for transmitting binary images of files.

SAGE4UTIL  
CONFIGURATION CONTROL

The XON/XOFF protocol may be configured for either direction of transmission or both directions of transmission. When set up in the Input mode, the receiver will transmit XON and XOFF characters to control the transmitting from the opposite system. When set up in the Output mode, the receiver will respond to XON and XOFF characters which are received to start and stop the transmit direction.

**REMOTE PORT DSR - DATA SET READY**

The 'G' selection is provided to control a transmit check on Data Set Ready. When low level signal handshaking is needed on the Remote Serial channel, the Data Set Ready input should be used instead of the Clear to Send input (see writeup on Hardware-Printer Port). When a character is transmitted the DSR bit is checked. If DSR is not active, a delay is scheduled (value controlled by 'H' selection) before the next test.

The 'H' option specifies the delay in 1/64000's second between polling attempts of the Data Set Ready signal.

## ● C & D - Right & Left Floppy

In order to read (and write) as many different formats as possible, the floppy configuration sections allows considerable flexibility in setting the format parameters. The first menu presents commonly used formats (A-K) which are pre-defined.

The I option will refer you to the Low Level Configuration option in order to setup specific parameters. Option I is only for display and not for selection. If the low level parameters do not match a standard option then this line is displayed.

### Right (or Left) Floppy Drive Selection

- A - SAGE double side, 80 track (1280 blocks) \*
- B - SAGE double side, 40 track ( 640 blocks)
- C - IBM single side, 40 track Universal Media (320 blocks)
- D - IBM double side, 40 track (640 blocks)
- E - Network Consulting single side, 40 track (400 blocks)
- F - Network Consulting double side, 40 track (800 blocks)
- G - Network Consulting double side, 80 track (1600 blocks)
- H - IBM double side, 80 track (1280 blocks)
- I - Non Standard Drive Configuration
- J - No drive equipped
- K - SAGE 10 sector per track, 80 track (1600 blocks)

Select Menu item <CR exits, ! aborts>:

## 80 vs 40 TRACK DRIVES

The 80 track (96 TPI) diskettes may only be accessed on systems with 80 track drives. The 40 track (48 TPI) diskettes may be read on an 80 track drive but cannot be easily written. Note that only SAGE 80 track or 40 track diskettes may be used to start (bootstrap) the system. The PROM driver used for bootstrapping does not handle all the varied formats which are configurable by the BIOS.

## IBM FORMAT

IBM initially provided only single sided drives on their personal computer. Therefore when they came out with double sided drives, they deviated from the optimum cylinder orientation so that the the same scheme would read both the

## SAGE4UTIL CONFIGURATION CONTROL

single sided and double sided drives. With the IBM track format, data is stored in ascending track order on side zero and then back in descending track order on side one. The normal SAGE II/IV method is to store data on side zero and then side one of each track before stepping the head to the next cylinder.

### NCI FORMAT

A special sector numbering scheme was developed by Network Consulting Incorporated for their BIOS on the IBM Personal Computer. It allows their software to automatically distinguish between their 10 sector per track diskettes and the normal 8 sector per track IBM standard diskettes. The SAGE II/IV provides a compatibility mode to this format but does not attempt to automatically distinguish which format is being used.

### SAGE 10 SECTOR

Note: SAGE also provides a 10 sector per track format allowing 1600 blocks of data. This generally works but does stretch the drive specifications. It is not recommended for a distribution format. The SAGE 10 sector format diskettes may be bootstrapped.

### SOFTECH MICROSYSTEMS UNIVERSAL MEDIA

Softech Microsystems has chosen a format to standardize their 5 1/4" diskette distribution. This format is currently compatible with the single side, IBM, 40 track selection.



● E - RAM Disk

Typing 'E' to the Configuration Manager prompt displays:

RAM Disk Configuration

A - Base of Ram Disk (0 = disabled)	023400
B - Top of Ram Disk (0 = to BIOS)	0FB490
C - Boot to Ram Disk flag	On

Select Menu item <CR exits, ! aborts>:

This option allows the user to decide how to utilize extra memory in the system which is not being used by the p-System. Enabling the RAM Disk option allows use of all or a part of the extra memory as device #11:. The Boot option enables (on ) or disables (off ) the process of copying of the boot disk to RAM and then booting the system from device #11:.

When the RAM Disk is enabled, the bottom and top addresses for the RAM Disk memory must be specified.

The base of RAM Disk is normally shipped as 23400. This value is dependent on the setting of the CODE POOL area, reference SETUP.

A value of zero for the Top of RAM Disk memory will default to the first location available below the BIOS & Stack. When displayed under the On-Line Configuration, this will show the actual address for the top of RAM Disk.

SAGE4UTIL  
CONFIGURATION CONTROL

● F - Printer

The 'F' option is used to set the printer to the proper channel. The channel must then be set to the proper configuration from its own menu.

Printer Configuration Control

A - Printer port assignment	Parallel port
B - Linefeed after carriage return	On

Select Menu item <CR exits, ! aborts>:

The linefeed option may be turned off for printers which automatically insert a linefeed after a carriage return.

Note that this option is currently only supported for the p-System. Most operating systems do not have the appropriate facilities necessary to inhibit the automatic generation of the line feed.

Printer Port Assignment

A - Remote serial channel	
B - Parallel port	*
C - Extra serial channel #1	
D - Extra serial channel #2	
E - Extra serial channel #3	
F - Extra serial channel #4	
G - Disabled	

Select Menu item <CR exits, ! aborts>:

● G-J - Extra Serial Ports #1-#4

The extra serial ports are set up much like the terminal channel and the Remote channel.

Extra Serial Channel #1 Control

A - Extra Serial Channel Baud Rate	19200 baud
B - Extra Serial Channel Parity	Even parity
C - Extra Serial Channel Stop Bits	1 Stop Bit
D - Extra Serial Channel Data bits	7 Data Bits
E - Xon/Xoff for input	Off
F - Xon/Xoff for output	Off

Select Menu item <CR exits, ! aborts>:

Note: 200 baud is not a supported option for the extra serial channels.

SAGE4UTIL  
CONFIGURATION CONTROL

● K - Parallel Port

This option controls how the parallel port is accessed, with interrupts on or in a polling loop.

Parallel Port Control

A - Interrupt (vs Scheduled Polling)	On
B - Polling attempts before delay	500
C - Delay before re-polling	236

Select Menu item <CR exits, ! aborts>:

Scheduled Polling is used for printers which use the Centronics parallel port definition but rely on the system polling the Busy signal from the printer to determine when the next transmission is possible.

Using this option, after a character is output the routine will poll the Busy line for a selected number of times. If the printer has an internal buffer it may be able to receive the next character within a reasonably short time. If the printer is still busy after the specified number of polling cycles, a configurable delay (option "C" ) is scheduled which releases the processor for other work. After each delay interval the processor returns to check if the printer is busy. In this manner a normally polled printer will not completely tie up the processor.

● L - Time Adjustment

Selecting 'L' will allow changing a time adjustment factor which may be necessary to prevent the Real Time clock from drifting slightly over a period of several days. The Real Time Clock values are derived from the processor clock which does not have the precision required to keep accurate time over long periods.

The SAGEDATE utility displays both the current time and the last time that the Real Time Clock was set.

Integer values for the number of seconds to adjust over the number of days may be easily determined. If the Real Time gains, the seconds of adjustment value should be negative. If the Real Time loses, the seconds of adjustment value should be positive. The number of days cannot exceed 100 and the number of seconds cannot exceed + or -60. A zero number of days (or seconds) disables the adjustment. The program will ask:

Time Adjustment

A - Seconds of time adjustment 0  
B - In number of days 0

Select Menu item <CR exits, ! aborts>:

This time drift factor is only important if the SAGE II/IV is to be left running without reset or power down for a period of over two weeks. Also, the factor is only important if an accurate time value is required from the SAGE II/IV by an applications program.

## SAGE4UTIL CONFIGURATION CONTROL

### ● M - Low Level Configuration

The Low Level Configuration manager defines parameters for the channel maps and disk formats.

#### Low Level Configuration

- A - BIOS Channel Map ( 0 to 15)
- B - BIOS Channel Map (16 to 31)
- C - Left Floppy Details
- D - Right Floppy Details
- E - Shared Floppy Details
- F - Winchester #1
- G - Winchester #2
- H - Winchester #3
- I - Winchester #4
- J - Operating System Information
- K - Auxiliary Device Information

Select Menu item <CR exits, ! aborts>:

Only selections "C", "D", and "E" can be run from the Multi-User environment.

### **BIOS Channel Map**

The most common changes made to the Channel map are for the hard disk partitions.

For example, Channel 6 is the PRINTER: for the p-System. If you have a serial printer attached to the REMOTE port, the device number should be "8". If you have a parallel printer, the device number should be "6". Device numbers are also called "Physical channels" in the SAGE documentation.

Refer to the section called "BIOS CHANNEL MAP" in the SAGE II/IV TECHNICAL MANUAL for a discussion on how channels and devices are mapped together in the SAGE. Basically, each logical channel is assigned a physical device. The "channels" transport information from the routines to the physical device.

The printer is typically configured to its various options by selecting "Printer" from the main configuration menu,

rather than through the channel map.

The following map shows the default set up by the factory.

BIOS Channel Map (0 to 15)

A - Channel 0 device = 0	Q - Channel 0 subdevice = 0
B - Channel 1 device = 1	R - Channel 1 subdevice = 0
C - Channel 2 device = 2	S - Channel 2 subdevice = 0
D - Channel 3 device = 3	T - Channel 3 subdevice = 0
E - Channel 4 device = 4	U - Channel 4 subdevice = 0
F - Channel 5 device = 5	V - Channel 5 subdevice = 0
G - Channel 6 device = 6	W - Channel 6 subdevice = 0
H - Channel 7 device = 7	X - Channel 7 subdevice = 0
I - Channel 8 device = 8	Y - Channel 8 subdevice = 0
J - Channel 9 device = 9	Z - Channel 9 subdevice = 1
K - Channel 10 device = 9	0 - Channel 10 subdevice = 2
L - Channel 11 device = 11	1 - Channel 11 subdevice = 0
M - Channel 12 device = 9	2 - Channel 12 subdevice = 3
N - Channel 13 device = 9	3 - Channel 13 subdevice = 4
O - Channel 14 device = 9	4 - Channel 14 subdevice = 5
P - Channel 15 device = 9	5 - Channel 15 subdevice = 6

Select Menu item <CR exits, ! aborts>:

BIOS Channel Map (16 to 31)

A - Channel 16 device = 9	Q - Channel 16 subdevice = 7
B - Channel 17 device = 9	R - Channel 17 subdevice = 8
C - Channel 18 device = 9	S - Channel 18 subdevice = 9
D - Channel 19 device = 9	T - Channel 19 subdevice = 10
E - Channel 20 device = 9	U - Channel 20 subdevice = 11
F - Channel 21 device = 9	V - Channel 21 subdevice = 12
G - Channel 22 device = 9	W - Channel 22 subdevice = 13
H - Channel 23 device = 9	X - Channel 23 subdevice = 14
I - Channel 24 device = 9	Y - Channel 24 subdevice = 15
J - Channel 25 device = 0	Z - Channel 25 subdevice = 0
K - Channel 26 device = 0	0 - Channel 26 subdevice = 0
L - Channel 27 device = 0	1 - Channel 27 subdevice = 0
M - Channel 28 device = 13	2 - Channel 28 subdevice = 0
N - Channel 29 device = 14	3 - Channel 29 subdevice = 0
O - Channel 30 device = 15	4 - Channel 30 subdevice = 0
P - Channel 31 device = 16	5 - Channel 31 subdevice = 0

Select Menu item <CR exits, ! aborts>:

SAGE4UTIL  
CONFIGURATION CONTROL

**Right & Left Floppy configuration**

The 'C or D' selection for Left or Right floppy configuration will bring up an alternate menu which allows changing low level parameters of the floppy disk driver. Note that most selections require knowledge of floppy disk recording protocols and possibly controller information. The Low Level parameters of the Floppy configuration are rarely changed from the factory setup unless the user is attempting to read or write to a non-standard format. The alternate menu is shown below:

Low Level Left Floppy Configuration

A - Number of sides	2
B - Number of cylinders	80
C - Sectors per track	8
D - Bytes per Sector	512
E - Retries	3
F - Motor on delay factor	9600
G - Data Length	255
H - Gap 3 parameter	42
I - Gap 3 for format	80
J - Pattern for format	229
K - Skew for format	0
L - IBM track format	Off
M - NCI 10 sects/trk	Off
N - Read 48 on 96 TPI	Off
O - Read after write	On
P - Ignore errors	Off

Select Menu item <CR exits, ! aborts>:

'A' asks for 0, 1 or 2 sides for the diskette. Zero should be specified if the drive is not equipped. This will return an early error without having to go through a timeout process.

'B' asks for the number of cylinders on the diskette. Cylinders and tracks are often used in the same context. A cylinder represents a head position which may access a track on each side of a double sided diskette.

'C' asks for the number of sectors per track. Typical values are 8 for 512 byte sectors or 16 for 256 byte



sectors. The Gap 3 parameter and the Gap 3 for formatting also must be modified for a specific Sectors per Track and Bytes per Sector combination. Also the density selection interacts with all these parameters.

'D' asks for the number of bytes per sector. Typically this is 512 for 8 sectors per track or 256 for 16 sectors per track. The Gap 3 parameter and the Gap 3 for formatting also must be modified for a specific Bytes per Sector, Sectors per Track, and density combination. Note also that selections of Bytes per Sector above 512 are not currently supported.

'E' asks for the number of retries. This question should be answered with the number of retries that the diskette driver should make before returning an error. The system is normally shipped with 3 retries specified but this may be increased to attempt to access data on a marginal diskette.

'F' asks for the Motor on delay factor. This should be given in hexadecimal as the number of 1/64000ths of a second for the delay.

'G' asks for Data Length. This parameter is only used by the controller when the sector size is less than 256 bytes per sector. In these cases the Data Length is the number of bytes per sector (typically 128). For all other cases the Data Length is normally set to 255.

## SAGE4UTIL CONFIGURATION CONTROL

'H' asks for the Gap 3 parameter (in decimal). This parameter is required by the controller for Read and Write commands to avoid the splice point between the data field and the ID field of contiguous sectors. The value depends on the combination of Bytes per Sectors, Sectors per Track, and density selection. Suggested values from the controller documentation are:

Density	BPS	SPT	Gap 3	Gap 3 for format
Single	128	18	7	9
	128	16	16	25
	256	8	24	48
	512	4	70	135
Double	256	18	10	12
	256	16	32	50
	512	8	42	80

'I' asks Gap 3 for formatting. Values for this parameter are used when formatting a diskette and are contained in the Gap 3 table under selection 'H'.

'J' asks for a Pattern for formatting. This value (0 to 255) is written into each data byte during the formatting of a diskette. The normal default value is 229 (E5 hex). Note that certain operating systems (such as CP/M) may require a specific format pattern.

'K' asks for a Skew factor. This value is normally zero. The 10 sector per track formats generally specify a two sector skew to be formatted onto the diskette. This improves the performance when accessing the diskette over track boundaries. The IBM format is normally identical to the standard SAGE 8 sector per track format as the difference is only in where the data is written. On 10 sector per track diskettes with IBM format, the skew is reversed for head one because the tracks are accessed in decreasing order. The special NCI format also requires use of the IBM format selection.

SAGE4UTIL  
CONFIGURATION CONTROL

'L' sets the IBM track format compatibility on or off. For double sided diskettes, data is stored in ascending track order on side zero and then back in descending track order on side one. The normal SAGE II/IV method is to store data on side zero and then side one of each track before stepping the head to the next cylinder.

'M' will set the option to use a special sector numbering scheme developed by Network Consulting Incorporated. This scheme was implemented by NCI for their BIOS on the IBM Personal Computer. It allows their software to automatically distinguish between their 10 sector per track diskettes and the normal 8 sector per track IBM standard diskettes. Sectors are numbered from 9 to 18 (except the first sector on the device which is numbered 1).

'N' controls the feature which allows reading of 48 TPI diskettes on a 96 TPI drive. Note that writing from a 96 TPI drive to a 48 TPI diskette is not allowed because the 48 TPI drives cannot read the data. The 96 TPI drive is stepped two physical tracks for every track normally requested by the driver.

'O' controls the option to perform a read of information from sectors which have just been written. This Read after Write feature verifies that the controller can read back the information without detectable errors. This option slows down the writing process but should be left enabled to insure valid operation.

'P' controls the option to ignore errors from the floppy controller. The controller errors should never be ignored in normal operation. This option is only provided to allow a head alignment procedure to be performed using a special alignment diskette which contains unreadable data. The driver must continue to read the diskette so that signals may be observed with test equipment, even though the controller is detecting errors.

SAGE4UTIL  
CONFIGURATION CONTROL

**Shared Floppy Configuration**

These parameters are shared by the two floppies as they are set in the same controller. This means that the change will effect BOTH floppies and care should be taken to verify that this is really what the user wants.

Shared Low Level Floppy Configuration

A - Step Time (msec)	6
B - Head load	3
C - Head unload time	1
D - Double Density	On

Select Menu item <CR exits, ! aborts>:

'A' asks for the Step Rate. This is the number of milliseconds allowed between head step pulses by the controller. The value may be varied between 2 to 32 milliseconds (only even number values are supported).

'B' or 'C' is not advised. These parameters are set by the factory and should not be modified.

'D' will set the density option. The drives provided on the SAGE II/IV will normally be used in the double density mode. The single density option (Off) should only be required to access data from another system which provides only single density drives. The Sectors per Track, Bytes per Sector, and Gap 3 values must all be coordinated with the density selection.

### Winchesters #1 - #4 Configuration

The low level Winchester configuration allows the format to be changed for different types of drives. Normally this is only done by the factory or service centers.

**Winchester #1 Parameters**

A - Number of Cylinders	306	L - High Read Counter	1140
B - Bytes per Sector	512	M - Header Count	400
C - Step Time	250	N - Number of Heads	6
D - Slew Time	20	O - Number of Retries	10
E - Step Counter	16	P - Sectors per Track	19
F - Head Settle Time	840	Q - Select Bit	1
G - Cylinder for Precomp	306	R - Write Sync Bit	4000
H - Special types	0	S - Extra Head Settle	0
I - Test flags	0	T - Rd after Wt Retries	4
J - Track for shipping	329	U - Write Cycle Retries	2
K - Low Read Counter	1100		

Select Menu item <CR exits, ! aborts>:

### XVI.04 Auxiliary Device Information :

The Auxiliary Device Information is not used for the p-System.

Under CP/M-68K, the auxiliary device information is used to represent certain CP/M disk drive characteristics. Only the Floppy and Winchester field are used. For historical, RAM disk drive characteristics are stored in the Operating System Information. This is the format of an auxiliary device information field:

15	13	12	7	6	4	3	1	0
-----		-----		-----		-----		-----
BLKSIZ		DIRSIZ		OFFSET		unused		REMOV
-----		-----		-----		-----		-----

where

SAGE4UTIL  
Auxiliary Device Information

**BLKSIZ** represents the allocation block size of the CP/M disk. This is encoded as follows:

0 = 1024 bytes  
1 = 2048 bytes  
2 = 4096 bytes  
3 = 8192 bytes  
4 = 16384 bytes

**DIRSIZ** represents the number of directory entries on the CP/M disk. DIRSIZ \* 32 gives the number of directory entries.

**OFFSET** is the track offset of the directory. This is the number of reserved tracks before the CP/M directory starts.

**REMOV** if non-zero, marks the disk as removable. This should be normally set for floppy drives, but not set for removable hard drives.

```
Auxiliary Device Information
A - Keyboard          0000
B - Terminal          0000
C - Left Floppy      0000
D - Right Floppy     0000
E - Parallel Printer 0000
F - Remote Input     0000
G - Remote Output    0000
H - RAM Disk #1      0000
I - RAM Disk #2      0000
J - RAM Disk #3      0000
K - RAM Disk #4      0000
L - Extra Serial Port #1 0000
M - Extra Serial Port #2 0000
N - Extra Serial Port #3 0000
O - Extra Serial Port #4 0000
P - Winchester #1
Q - Winchester #2
R - Winchester #3
S - Winchester #4
Select Menu item <CR exits, ! aborts>:
```

● **Winchester Aux Device Info**

Selecting "P" - "S" will allow the user to set the Winchester Auxiliary Device information.

Winchester #1 Auxillary Device Information

A - Partition 0 0000  
B - Partition 1 0000  
C - Partition 2 0000  
D - Partition 3 0000  
E - Partition 4 0000  
F - Partition 5 0000  
G - Partition 6 0000  
H - Partition 7 0000  
I - Partition 8 0000  
J - Partition 9 0000  
K - Partition 10 0000  
L - Partition 11 0000  
M - Partition 12 0000  
N - Partition 13 0000  
O - Partition 14 0000  
P - Partition 15 0000

Select Menu item <CR exits, ! aborts>:

## SAGE4UTIL

### Auxiliary Device Information

#### Operating System Information

32 bytes of information are available for use by the different operating systems. The information is displayed in Hexadecimal and no attempt is made to define their use. Refer to the specific operating system release to interpret the values. The p-System does not use this area.

#### Operating System Information

A - Word 0	0000
B - Word 1	0000
C - Word 2	0000
D - Word 3	0000
E - Word 4	0000
F - Word 5	0000
G - Word 6	0000
H - Word 7	0000
I - Word 8	0000
J - Word 9	0000
K - Word 10	0000
L - Word 11	0000
M - Word 12	0000
N - Word 13	0000
O - Word 14	0000
P - Word 15	0000

Select Menu item <CR exits, ! aborts>: